



Use and maintenance manual
MAN.218 Rev.8



ORIGINAL

CMC S32

Mobile elevating work platform

Brand **C.M.C.**
Model **S32**



0 ▶▶ Introduction ◀◀

Thank you for the trust you have showed us buying a C.M.C. mobile elevating work platform (MEWP). We are sure you will be pleased with your choice.

0.1 ▶ Content of the manual ◀







This manual contains the technical specifications and the instructions for transfer, use and maintenance of the MEWP. While drawing up this manual, we took into consideration all the operations that are part of a normal use and a regular maintenance of the machine. So, for a correct and optimum use, you must follow the described instructions carefully.

This manual has been drawn up in order to:

- ❑ Show the technical features of the machine;
- ❑ Describe the control stations and their commands;
- ❑ Provide with the instructions for the transport, placement and use of the machine;
- ❑ Describe the safety devices;
- ❑ Point out the potential risks and/or possible dangerous situations;
- ❑ Provide with the necessary instructions for the ordinary maintenance operations;
- ❑ Provide with the instructions for the filling of the check register.

📖 THE USE AND MAINTENANCE MANUAL IS CONSIDERABLE AS A PART OF THE MACHINE. In case of sale of the MEWP, please give this manual to the new owner.

LEGEND OF SYMBOLS USED IN THIS MANUAL:

	(CAUTION)	= it warns the user about the risk of serious damages to people or to part of the equipment or the machine, if you do not obey the safety regulations.
	(WARNING)	= it notifies the possibility of minor injuries to people or little damages to the platform or machine parts.
	(FORBIDDEN)	= prohibition signal.
	(OBLIGATION)	= obligation signal.
	(CAUTION)	= it warns the user about the risk of environmental pollution.
*	(OPTIONAL)	= it indicates an optional outfit.
	(IMPORTANT NOTE)	= indicates information and suggestions useful to work with the MEWP.

- ➔ This manual is addressed to:
- **users:** operators, ground assistants, guard staff, safety manager, service manager;
 - **manufacturers, dealers, owners, lessors or lessee, brokers.**



0.2 ▶ Disclaimer ◀

C.M.C. declines all responsibility in case of partial or total non-observance of the following instructions

- ➔ Before any operation with the machine, the user is obliged to read carefully the text of this manual, with reference to sections relative to specific work activity to perform.
- ➔ The use of the machine must be entrusted only to trained and authorized staff. This manual cannot replace in any way a suitable experience that the staff in charge must have gained previously on similar machines or that they will be able to get on this machine, under the guidance of an already trained staff.
- ➔ The user must work within the functional limits of the machine and perform a constant and diligent maintenance, using only original spare parts indicated by C.M.C.
- ➔ The operator shall carefully know the safety standards foreseen by national and international legislations and apply them during all operations with the MEWP.

☞ **The guarantee of proper functioning and full compliance of the machine with the intended service is strictly dependent on the correct application of all the instructions contained in this manual.**

☞ **The non-compliance with the previous items automatically invalidates the warranty.**

0.3 ▶ Where and how to store the manual ◀

- ➔ **The manual must be stored and kept in the best possible condition (away from sunlight), in a suitable place, for the purpose of always being available for consultation.**
- ➔ **This manual (or its copy) must always be on the machine** (in a case near the turret) for an immediate consultation by the operator during working operations.

- ➔ **Another copy shall be held by the basket operator during the working period inside the internal documents case.**
- ➔ **In case of loss or deterioration, the replacement documentation must be requested to C.M.C. s.r.l, citing the code of this manual.**

0.4 ▶ Legislative references ◀



This manual has been drawn up according to the following national and international laws and directives:

Directive 2006/42/CE	EN 280:2015	EN 13001-3-1
Directive 2014/35/UE	Directive 2000/14/CE	EN ISO 12100
ISO 13849-1-2	ISO 3864	EN 60068-2-64
ISO 13850	ISO 4302	EN 60204-1
ISO 13854	ISO 4305	EN 60204-32
ANSI/SAIA A92.20-2020	ANSI/SAIA A92.24-2018	IEC 60529
ANSI/SAIA A92.22-2020	ANSI Z359.1	EN 62061
CAN/CSA B354.6 (2017)	CAN/CSA B354.7 (2017)	ISO 13857
AS/NZS 1418.10-2011	AS NZS 1418.10-2011_A1-2017	ISO 20381



0.5 ▶ Changes and integrations ◀

The information and legislative references present in this manual are those in force when the machine has been placed on the market.

Due to the constant and continuous improvement of their product by the manufacturers, the supplied machine could present some technical specifications different from those described on this manual. Any change will be however accompanied with specific documents attached explaining functional characteristics. In case of differences in comparison with the basic contents of this manual, the user is kindly asked to contact C.M.C. to receive supplementary technical specifications.

As this manual includes both current and optional components, you could find information not applicable to your machine.

C.M.C. reserves the right to update its production and its instruction manuals (without prior notice) according to the development of the technique, to the acquisition of new experiences and/or the change of law provisions, without being anyway obliged to intervene on the previously sold machines and on their manuals.

No part of this publication can be translated, modified or reproduced (even partially) without the expressed authorization of C.M.C. s.r.l.

C.M.C. reserves the right to modify - totally or partially - any data or specification of this publication (without prior notice).

Data and references indicated in this manual are those in force at the time of printing.

Year 2020
C.M.C. s.r.l.



1 ►► Specifications ◀◀

1.1 ► Technical sheet ◀

PERFORMANCE

Max. working height	32,00 m	104.99 ft
Min. working height	-3,20 m	10.50 ft
Max. working outreach (with 120 kg)	16,00 m	52.49 ft
Max. working outreach (with 220 kg)	14,20 m	46.59 ft
Max. load on the basket	220 kg	485 lb
Jib movement	140°	
Turret rotation	+/-200° (tot. 400° continuous)	
Basket rotation	+/-90°	
(P) Max. slope to stabilize	16° / 29%	
(W) Max. ramp attack slope (front/rear) with tracks enlarged	16°-18° / 29%-32%	
(X) Max. slope to travel (longitudinally/transversally)	19°-8° / 34%-14%	
Travel speed	0,5 - 1,2 km/h	0.31 - 0.75 mph

DIMENSIONS

(A) Basket height	1,10 m	3.61 ft
(B) Basket width	0,70/0,60 m	2.30/1.97 ft
(C) Basket length	1,70/1,20/0,80 m	5.58/3.94/2.62 ft
(D) Total length	7,50 m	24.61 ft
(E) Length without basket	6,98 m	22.90 ft
(F) Height in driving position with tracks closed	1,99 m	6.53 ft
(F') Height in driving position with tracks opened	2,35 m	7.71 ft
(G) Total width without basket	1,90 m	6.23 ft
(G') Total width with tracks closed, boom extended, and basket coupled	1,56 m	5.12 ft

(G'') Total width (with one track closed and one raised)	1,73 m	5.68 ft
(H) Clearance from the ground in transport position	0,42 m	1.38 ft
(H') Max height that can be climbed over to stabilize	0,56 m	1.84 ft
Tracks dimensions (L x W)	2,45 x 0,32 m	8.04 x 1.05 ft
Width tracks adjustment	1,56/1,90 m	5.12/6.23 ft
Height tracks adjustment	0,05/0,46 m	0.16/1.51 ft
(J) Max. longitudinal stabilization	7,75 m	25.43 ft
(K) Max. cross stabilization (rear)	5,21 m	17.09 ft
(K') Max. cross stabilization (front)	4,93 m	16.17 ft
(M) Medium cross stabilization (rear)	4,46 m	14.63 ft
(M') Medium cross stabilization (front)	4,17 m	13.68 ft
(N) Min. longitudinal stabilization	6,15 m	20.18 ft
(O) Min. cross stabilization (rear)	3,72 m	12.20 ft
(O') Min. cross stabilization (front)	3,14 m	10.30 ft
Outriggers plate Ø	0,24 m	0.79 ft

WEIGHT AND PRESSURES

Total weight	7280 kg	16050 lb
(R) Max. pressure on the foot	9,69 Kg/cm ² (95,1 N/cm ²)	137.82 lb/in ²
(S) Max. pressure on the track	0,95 Kg/cm ² (9,34 N/cm ²)	13.51 lb/in ²
(T) Max. pressure in travel	565 Kg/m ² (5,54 KN/m ²)	115.72 lb/ft ²
(U) Max. pressure in work (4 feet opened)	206 Kg/m ² (2,02 KN/m ²)	42.19 lb/ft ²
(V) Max. pressure in work (4 feet closed)	224 Kg/m ² (2,20 KN/m ²)	45.88 lb/ft ²
(Z) Max. pressure in work (2 feet closed + 2 feet opened)	185 Kg/m ² (1,81 KN/m ²)	37.89 lb/ft ²



POWER	
Standard hydraulic feed	1) Kubota D902-E4B diesel, 16.1 kW (21.6 HP), 3200 rpm
*Optional feeds	2) Electric engine 380/230/240-460 V 3) Motor G0901306, 9 kW, 48 V, with lithium batteries 300 Ah 4) Hybrid motor (diesel + lithium batteries)
Fuel tank capacity	30 l

Max values (speed/force) allowed according to USA/EU standards	
Max allowed lifting and descending speed of the MEWP	0,4 m/s (1.31 ft/s)
Max allowed boom extension and withdrawal speed	0,4 m/s (1.31 ft/s)
Max allowed rotation speed	0,7 m/s (2.3 ft/s)
Max allowed manual force in the basket with 1 operator	400 N

		Tightening torque
Bolts of the bearing	M16 cl 10.9	28 daNm

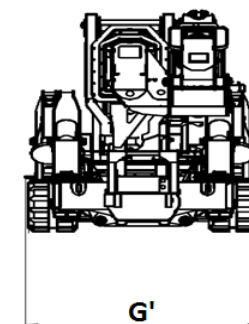
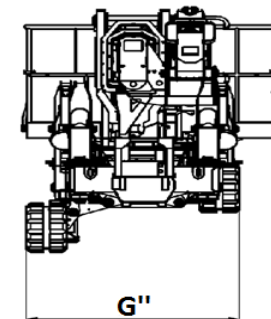
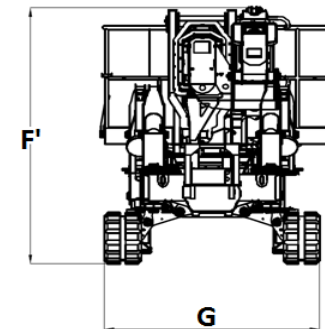
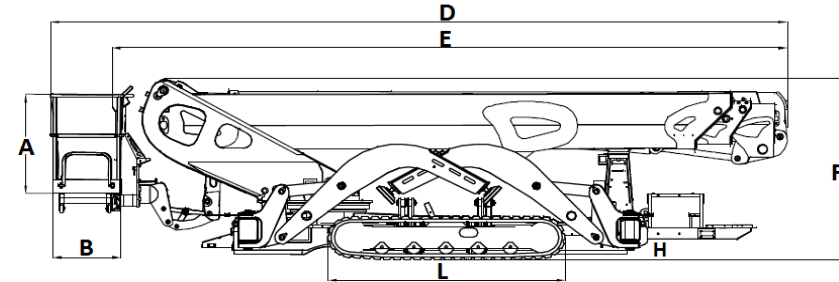

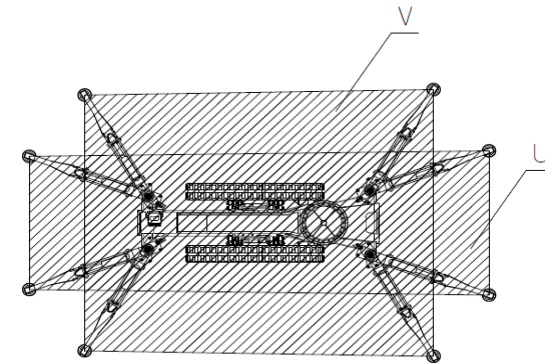
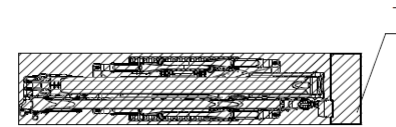
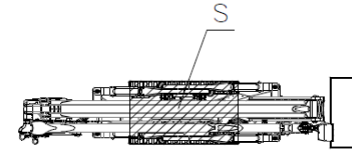
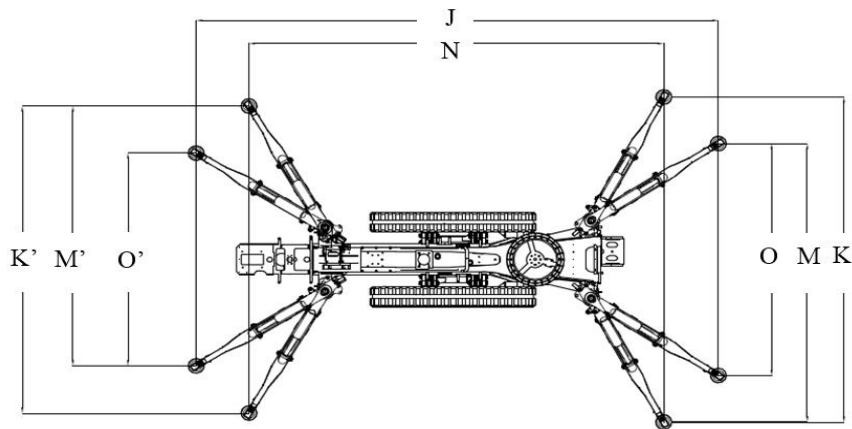
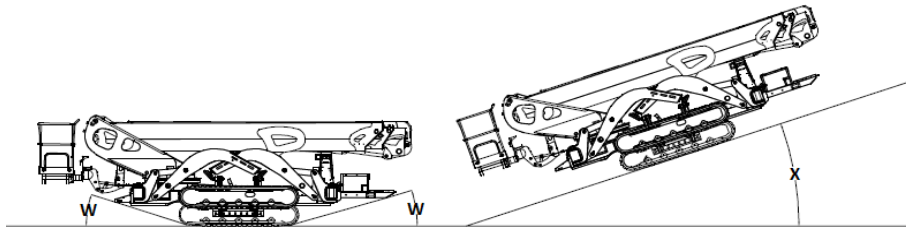
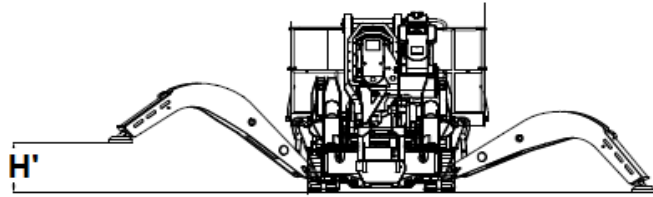



1.2 ► Identification plate ◀

On the turret, there is a plate with (engraved) all the MEWP identification data:

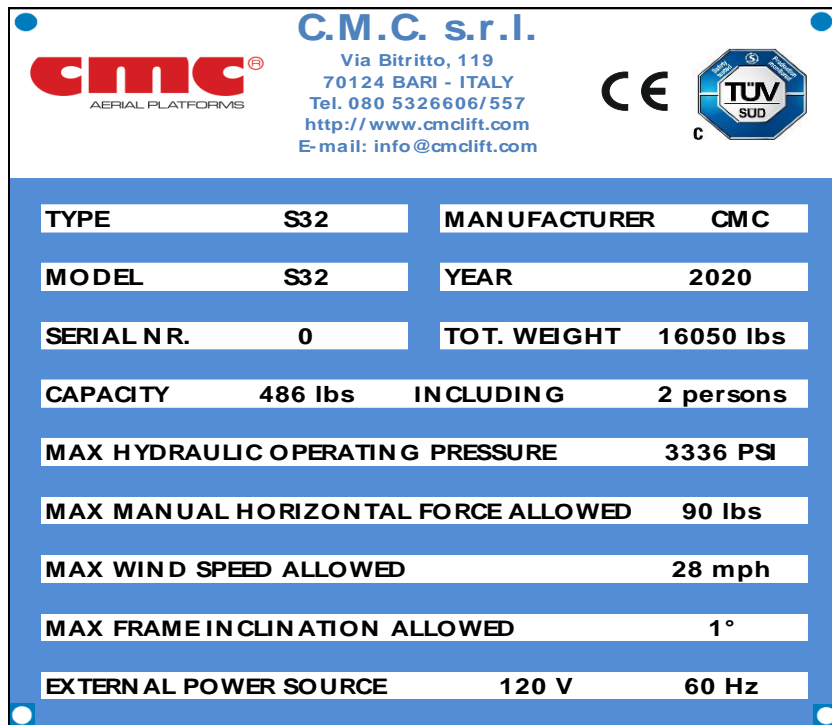

Picture 1: identification plate.

1.3 ► CE certification ◀

C.M.C. s.r.l. states under its own responsibility that **S32** was designed and produced in compliance with national and European standards, and that the machine is identical to the model submitted to control and test for the “CE certification” by the Notified Institute **nr. 1878 - VERICERT s.r.l. - via L. Masotti, 5 - 48124 Fornace Zarattini (RA) - Italy.**

A copy of the CE Certificate is attached to the manual.

1.4 ► TÜV certification ◀

C.M.C. s.r.l. states under its own responsibility that **S32** was designed and produced in compliance with US standards ANSI/SAIA A92.20:2018 and that the machine is identical to the model submitted to control and test for the “TÜV certification” by **TÜV SÜD America Inc.**

TÜV SÜD America Inc. is an OSHA recognized NRTL and a Standards Council of Canada accredited certification body.

1.5 ► Classification ◀

The mobile elevating work platform (MEWP) **S32** belongs to **group B**: the vertical projection of the area center of the MEWP in different platform configurations specified by the manufacturer can be outside the tipping lines (EN 280 par. 1.4 - ANSI/SAIA A92.20 par. 3).

As for the displacement, it belongs to **type 1**: travelling is only allowed with the MEWP in its transport configuration or in the stowed position (EN 280 par. 1.4 - ANSI/SAIA A92.20 par. 3).



1.6 ▶ Loading cycles ◀

The machine is expected to last for 40.000 loading cycles¹ (i.e. 10 years, for 40 weeks per year, for 20 hours per week, for 5 loading cycles per hour). **Within this term of time, the machine must undergo at least 2 (two) deep checks** (structural, mechanical, electric, elements, etc.), **in case of particularly heavy uses** (frequent use at the performance limit, particularly unfavorable environmental conditions such as steel plants, paper mills and so on) **it is better to increase checks**. Anyway, **it is a good rule to have the state of the machine checked by the manufacturer factory or by an authorized workshop, at least every 1500 - 2000 hours of work or once per year**.

¹Loading cycle: a cycle starts from the access position, continues performing the work and finishes returning to the access position.

1.7 ▶ Working diagram ◀

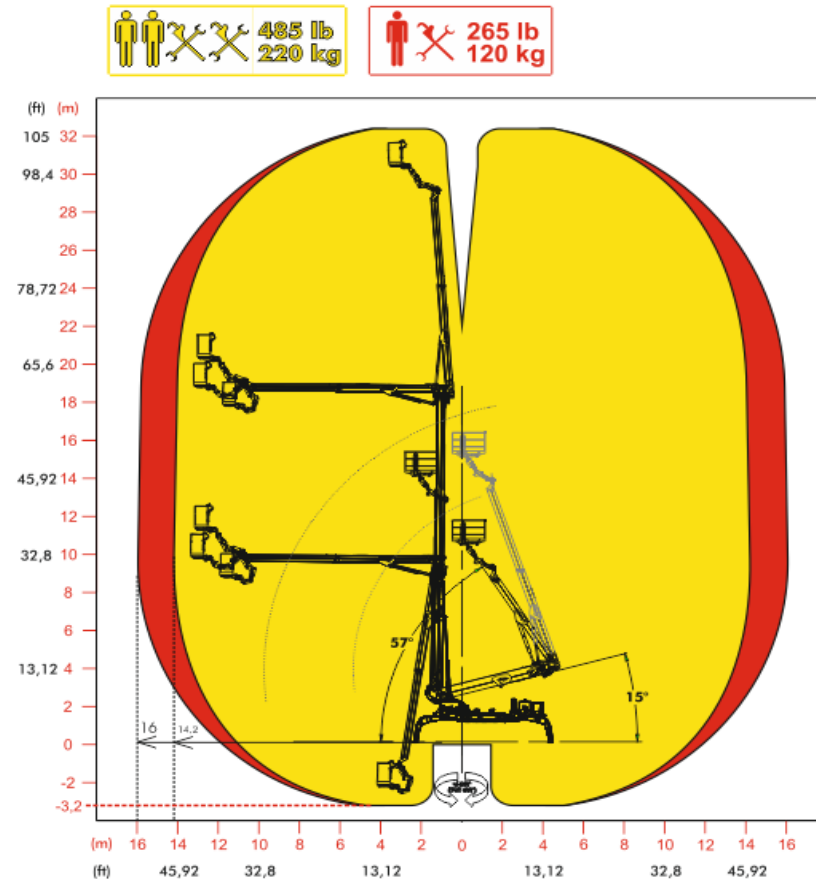

Picture 2a: working diagram
(valid only in the working area set by the outriggers placement).



*Gli sbarracci del presente diagramma si intendono al bordo della cesta. Le prestazioni di lavoro si intendono convenzionalmente aumentate di 1m.
 *The outreaches of this diagram are those at the edge of the basket. Work performances are to be considered conventionally increased 1m.

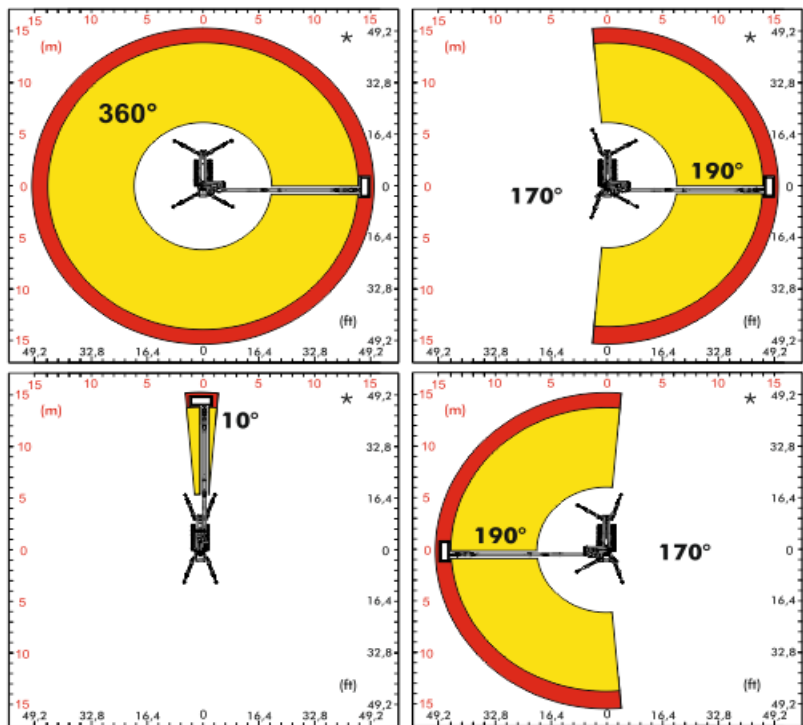

Picture 3b: stabilization areas.



2 ▶▶ Description and purpose ◀◀

2.1 ▶ Machine definition ◀

The machine is called **S32** and it is a **mobile elevating work platform (MEWP)**:

- machine/device intended for moving persons, tools and material to working positions, consisting of at least a work platform with controls, an extending structure and a chassis (ANSI/SAIA 92.20 par. 3);
- mobile machine intended to move persons to working positions, where they are carrying out work from the work platform, with the intention that persons are getting on and off the MEWP only at access positions at ground level or on the chassis and which consists as a minimum of a work platform with controls, an extending structure and a chassis (EN 280 par. 3.1).



It is forbidden to use the MEWP with methods and/or conditions other than those specified and approved by the manufacturer.

2.2 ▶ Machine purpose ◀

The MEWP **S32** is a machine which enables the operators to reach the working place when this is high positioned.

The machine has been designed for an essentially vertical use. It must be travelled only when it is totally folded in the transport position.

➔ The use of the machine is allowed only to professional staff, properly trained and specialized.

2.3 ▶ Description of the main components

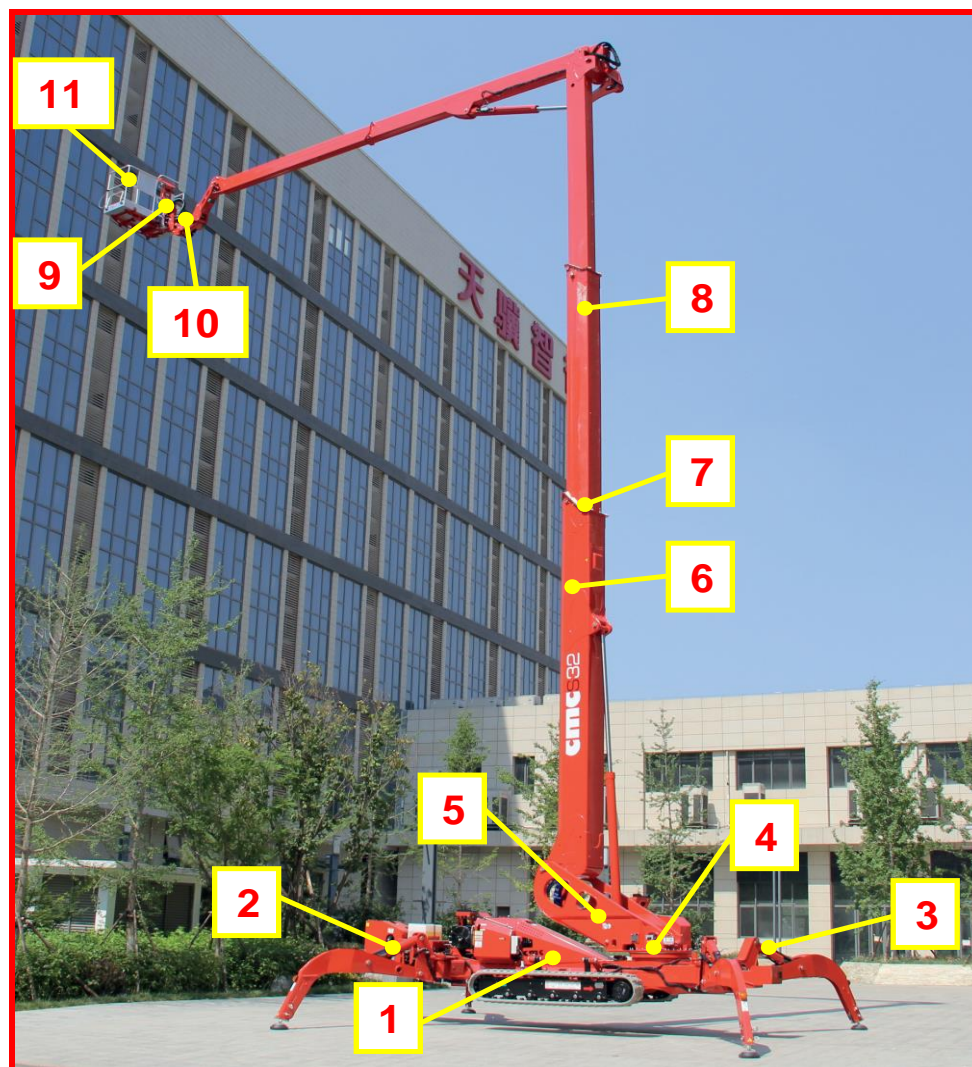

Picture 3: MEWP main components.



2.3.1 ▶ Frame

The frame **1** (Picture 3) is a structure in quality steel, able to equally divide the equipment's weight when the MEWP is in transport position. The frame has 4 oil-pressure jack beams for stabilization [2 front stabilizer cylinders 2 (Picture 3), 2 rear stabilizer cylinders 3 (Picture 3)]. The basis for the bearing is placed on the frame **4** (Picture 3). It enables the swinging of the equipment through the turn-table.

2.3.2 ▶ Turret

The turret **5** (Picture 3), in quality steel, is secured to the bushing (bearing). A hydraulic engine, with brake normally closed, constrained to the turret, allows the rotation of the superstructure.

2.3.3 ▶ First telescopic boom group

The first telescopic boom group **6** (Picture 3) is composed by three elements: a fixed boom and two extendable booms.

The extension (or withdrawal) of the telescopic boom is given by operating the "telescopic boom extension cylinder".

The movement of the boom (lifting and lowering) is given by the lifting hydraulic cylinder. Such cylinder is secured to the turret (cylinder side) and to the fixed boom (piston side) and is supplied with safety valves.

2.3.4 ▶ Second telescopic boom group

The second telescopic boom group **8** (Picture 3) is hinged to the first telescopic boom by a rod **7** (Picture 3). The telescopic boom is composed by three elements: one fixed boom hinged to the rod and two extendable booms.

The extension (or withdrawal) of the telescopic boom is given by operating the "telescopic boom extension cylinder".

The lifting (or lowering) of the telescopic boom is given by operating the "lifting cylinder of second telescopic boom group".

2.3.5 ▶ Jib

At the end of the second telescopic boom is hinged a boom named Jib **10** (Picture 3). The lifting or descent of the Jib is done by operating the "Jib lifting cylinder".

2.3.6 ▶ Basket

the basket **11** (Picture 3) is in aluminum tubulars and has a lateral opening to allow the entrance of the operators. The lateral opening is automatically shuttered and built to avoid accidental openings. The basket has attacks for safety belts, a guardrail 1,1 m high from the basket floor, an intermediate guardrail and a foot protecting band along all sides of the platform. The floor is in antiskid and auto-draining aluminum. The basket is connected to a support **9** (Picture 3) through which it is coupled with the jib.

3 ▶▶ Control stations ◀◀

3.1 ▶ Machine switching on/off station ◀



Picture 4: engine switch on/off station if Kubota.

By engine switch on/off station (Picture 4), allocated on the right side of the frame if the machine is equipped with Kubota diesel engine, there are:

- the **IK** ignition key: through it, it is possible to turn on the electric system and start the endothermic engine;
- the hourmeter.

3.1.1 ▶ Ignition of the endothermic engine

In order to start the endothermic engine, turn the **IK** key all the way to the right.

Before starting the engine, especially if the MEWP is used in workplaces with low atmospheric temperatures, it is advisable to heat the spark plugs of the machine motor while keeping the key in vertical position for a few seconds. The ignition of the endothermic engine can also be carried out with the help of the wired remote control or of the console in the basket.

Using the wired remote control:

- turn the key to the right;
- connect the wired remote control (link procedure in par. 3.2.2),
- move the lever in the Picture 5 upwards, present on the left side of the wired remote control under the joystick **J1** (Picture 14).

Otherwise, using the console (fixed) in the basket:

- turn the key to the right;
- press the endothermic engine start button **9** (Picture 11)
- the green light **5** (Picture 10) will light up on the console, to signal the correct power supply of the machine.



Picture 5: power on/off lever on the wired remote control.

To switch off the endothermic engine, you can alternatively:

- turn the ignition key all the way to the left;
- lift the lever in Picture 5, if the wired remote control has been used;
- press the endothermic engine start/stop button **9** again (Picture 11), if you are at the control station in the basket;
- press, in emergency situations, one of the emergency buttons on the machine (par. 4.6.1).



3.1.2 ▶ Switching on/off the electric motor (*optional)

If you choose to use the electric motor (*optional):

- connect the 110/120/230/380 V socket (Picture 6) on the machine to the nearest electrical source;



Picture 6: socket connection.

- from the wired remote control, start the engine by pushing the lever in Picture 5 downwards or alternatively from the console in the basket press the start button of the electric motor **10** (Picture 11);
- the power supply is signaled by the lighting up of the green led **5** (Picture 10) on the basket control station.

To switch off the electric motor, it will be enough to alternatively:

- turn the ignition key all the way to the left;
- lower the lever mentioned above of the wired remote control;
- re-press the on/off button **10** (Picture 11) on the basket console;
- press, in emergency situations, one of the emergency buttons provided on the machine (par. 4.6.1).

3.1.3 ▶ Other power supplies *optional

The machine can be supplied on request completely with a 48 V electric motor powered by 300 Ah lithium batteries or with a hybrid feed.



It is not possible to have the 48 V electric motor and the 110/120/230/380 V one activated on the machine at the same time.



It is not possible to turn on both the endothermic engine and the electric motor at the same time.

The start and stop of the 48 V electric motor will be the same shown above for standard electric motor.

To recharge the batteries:

1. couple the 230/380 V socket (power line) to the plug on the machine and lift the button provided on the machine's thermal magnetic panel;
2. the batteries will be charging and, if the electric system is ON, the progress of the charging process will be shown on control stations.



When the state of batteries charge, during the use, reaches the lowest level (under 10%), all work maneuvers will be interrupted, and it will only be possible to close the machine again.



It is absolutely forbidden to direct high-pressure jets of water onto the support containing the battery pack. High water pressure could generate serious and irreversible problems in the operation of the machine.

3.2 ▶ Platform control stations

The main standard platform control stations are:

- **AUTEC wired remote control** (Picture 13);
- **MOBA basket console** (Picture 9);
- **outriggers control station** (Picture 15);
- **display station** (Picture 17).

The *optional platform control station is:

- **AUTEC radio control** (Picture 13), **instead of wired remote control station.**



It is not possible to use two different control station at the same time.

The system will select as actual control station the first one that will be used by the operator. Once the AUTECH wired remote control station is linked, it will become the actual control station, and in order to select a different control station you need to turn off and back on the system by the ignition key or any of the emergency buttons on the machine (except the one on AUTECH wired remote control).

3.2.1 ▶ Basket control station



Picture 9a: basket control (exercise) station.

The platform MOBA control station (Picture 9a) on the basket has:

- **two joysticks J1 and J2** for aerial part and crawlers' operations;
- **a red mushroom-shaped emergency button EB** (on the right side of the control station): it stops the machine de-energizing the electrical circuits;



The emergency button has an auto-detent mechanical locking system; therefore, it is necessary to unlock the button turning it clockwise to reset its operability.

- **a series of control buttons/leds** described in the following table.

Command joysticks with a "dead man" system can be supplied as an *optional, in place of the standard ones.



Picture 9b: basket electric box.

Moreover, below the basket console, there is an electric box (Picture 9b) with:

- electropump activation button;
- 24 V socket;
- leds indicating lithium battery charge (*optional).

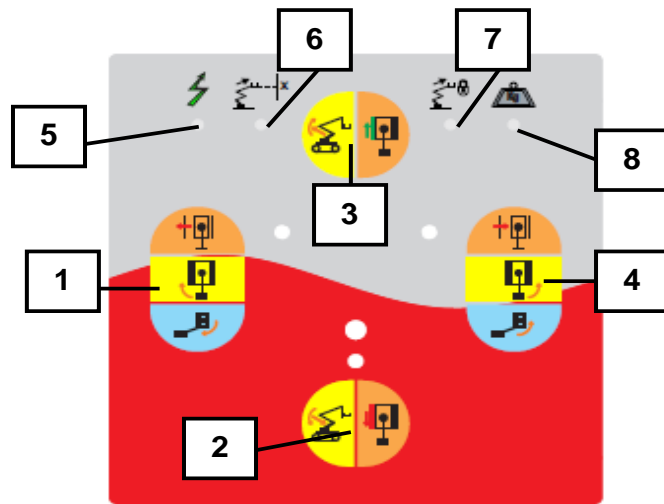

Picture 10: left side of basket console.

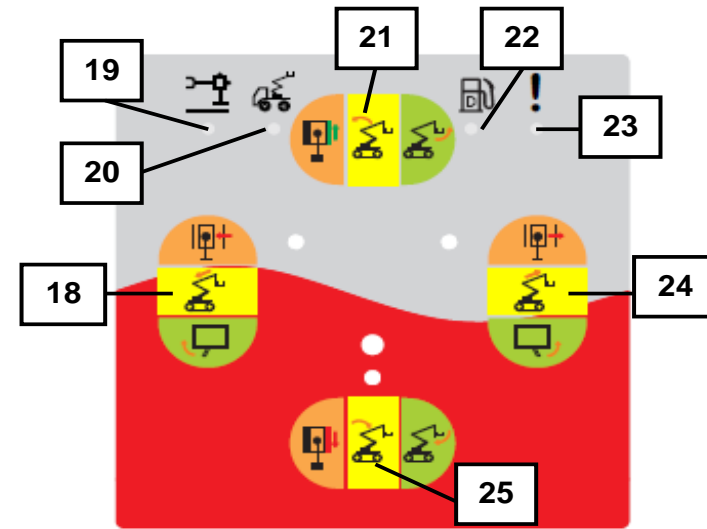

Picture 12: right side of basket console.

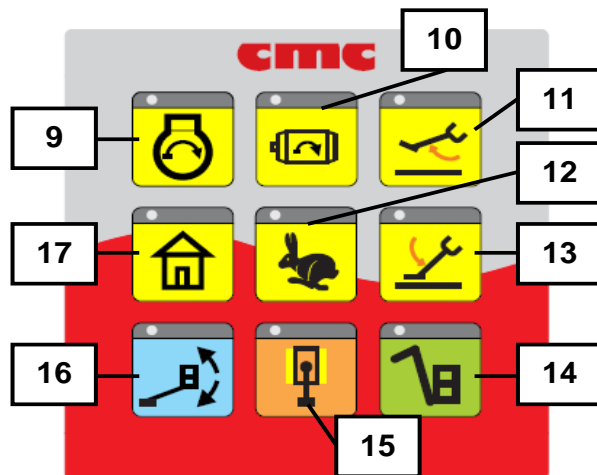

Picture 11: central side of basket console.

The basket control station allows the following maneuvers:

Button nr.	Operation description
1	Opening of the left track / clockwise rotation of turret / external leveling of basket
2	Return and lowering of boom 1 / backward movement of the left track
3	Lifting and extension of boom 1 / forward movement of the left track
4	Closing of the left track / counterclockwise rotation of turret / internal leveling of basket
5	MEWP power supply indicator
6	Pre-alarm light: maximum performance almost reached
7	Alarm light when reaching the maximum performance
8	Alarm light when reaching the load limit
9	Endothermic engine switching on/off button
10	Electric engine (*optional) switching on/off button



11	Automatic destabilization button from basket
12	Speed selection button among two predefined levels of increase: it has a flashing light in "hare" mode and a fixed one in "double hare" mode.
13	Automatic stabilization button from basket
14	Button for: 1. lifting/lowering jib 2. basket rotation
15	Tracks movement activation button
16	Deadman button for basket leveling operations, to be kept pressed during movement towards left/right of the joystick J1
17	"Home function" button
18	Closing of the right track / return of boom 2 / clockwise rotation of the basket
19	Stabilization consent light
20	Aerial part consent light
21	Forward movement of the right track / lifting of boom 2 / lifting of jib
22	Not used
23	Error/failure indicator light
24	Opening of the right track / extension of boom 2 / counterclockwise rotation of the basket
25	Backward movement of the right track / lowering of boom 2 / lowering of jib

3.2.2 ▶ Platform wired/radio control station

The switching on of the main standard wired AUTECH control station excludes the use of the basket control station.



Picture 13: platform wired remote/radio control station.

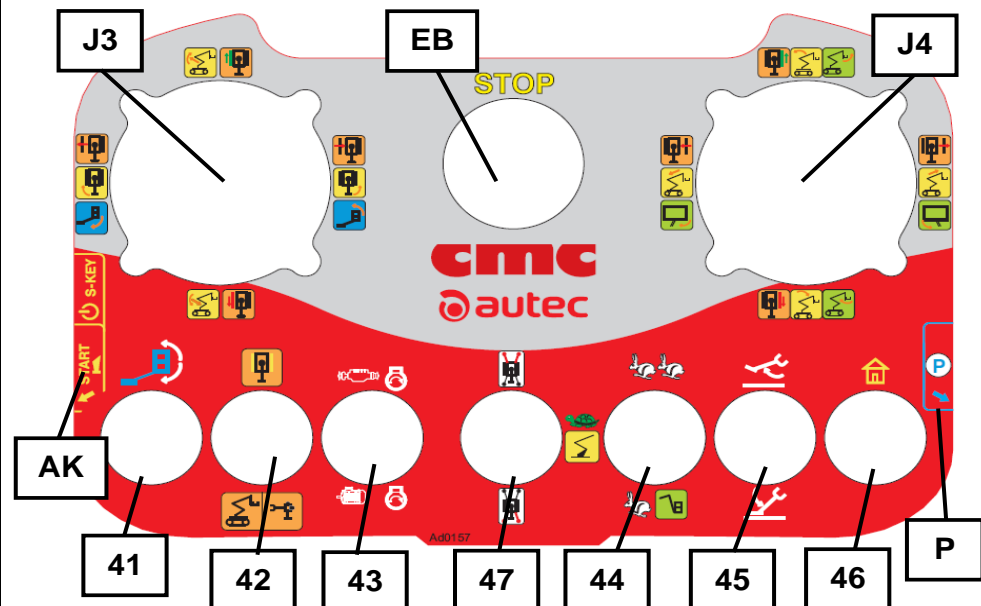

Picture 14: AUTECH wired remote control label.



The wired remote control station can become a wireless radio control station as *optional. It can be activated only by carrying out the following connection procedure:

 *Radio control link procedure*

1. ensure that the button **32** on outriggers control station (Picture 16) is activated;
2. to connect the radio control, press the green link button **SK** (Picture 13) on the bottom left side.
3. if the radio control is not correctly connected to the machine, an advice message will appear on the display; in addition, the green led on the underside of the display flashes intermittently and a buzzer on the electric box emits an intermittent acoustic signal.
4. press the link button again: when the connection is complete, the buzzer stops and the green led starts to light up at the rate of two flashes interspersed with a pause.

If the battery of the AUTECH radio control (*optional) is low, it could become a wired remote control, by connecting its plug to the machine power connection.

The AUTECH wired remote control has the following commands:

Command nr.	Operation description
J3	Left joystick for: first boom extension/lifting – forward travel of left track (upward) / left track widening – turret clockwise rotation – internal basket levelling (at left side) / left track narrowing – turret counterclockwise rotation – external basket levelling (at right side) / first boom return/lowering – backward travel of left track (downward)
EB	Emergency mushroom-shaped button
J4	Right joystick for: forward travel of right track – second boom lifting – jib lifting (upward) / right track narrowing – second boom return – basket clockwise rotation (at left side) / right track widening – second boom extension – basket counterclockwise rotation (at right side) / backward travel of right track – second boom lowering – jib lowering (downward)
41	Leveling “dead man” lever

42	Function selection lever: travel of tracks (upward) / outriggers and platform operations (downward)
43	Endothermic (upward) / electric (downward) engine start
44	Speed mode selector / selection lever for jib and basket operations (downward) / selection lever for aerial part maneuvers (in the middle)
45	Automatic stabilization (downward) / destabilization (upward)
46	“Home” button
AK	Wired/radio control activation key
P	Parking button
47	Front (upward) / rear (downward) outriggers lowering for loading/unloading operations

Moreover, the display of the wired remote control station shows possible functional anomalies and the corresponding error codes.



The emergency button has an auto-detent mechanical locking system; therefore, it is necessary to unlock the button turning it clockwise to reset its operability.



3.2.3 ▶ Outriggers control station



Picture 15: outriggers control station.

Through the control station in Picture 15, located on the right side of machine chassis, it is possible to perform stabilization/destabilization of the S32, to widen/tighten the tracks (par. 4.4.2.1), and enable/disable the use of the wired remote control station.

In addition, there is an **emergency red mushroom-shaped button** **EB** (Picture 39), that blocks the machine, removing the power supply to the control circuits. This button has priority over all other commands; thus, it allows only manual aerial part descent to the ground.



The emergency button has an auto-detent mechanical locking system; therefore, it is necessary to unlock the button turning it clockwise to reset machine operability.

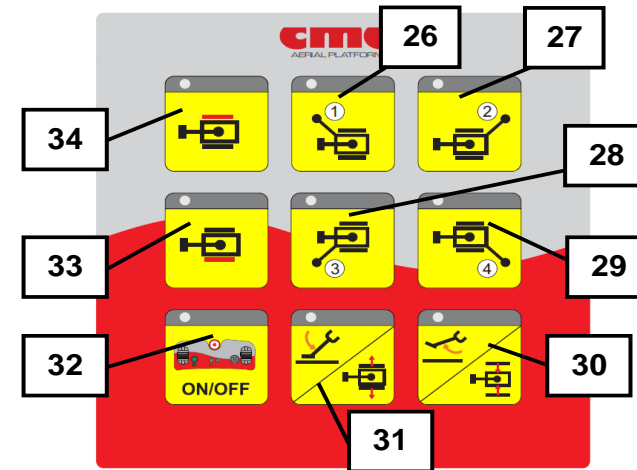

Picture 16: outriggers control station label.

Command nr.	Operation description
26	Left rear outrigger button
27	Left front outrigger button
28	Right rear outrigger button
29	Right front outrigger button
30	Destabilization/crawlers narrowing "dead man" button
31	Stabilization/crawlers widening "dead man" button
32	ON/OFF button to enable/disable wired remote control
33	Right crawler button
34	Left crawler button

3.2.4 ▶ Display control station

In this command station (Picture 17), through the **MB** buttons, it is possible to check and modify menu options and data.



Picture 17: display.

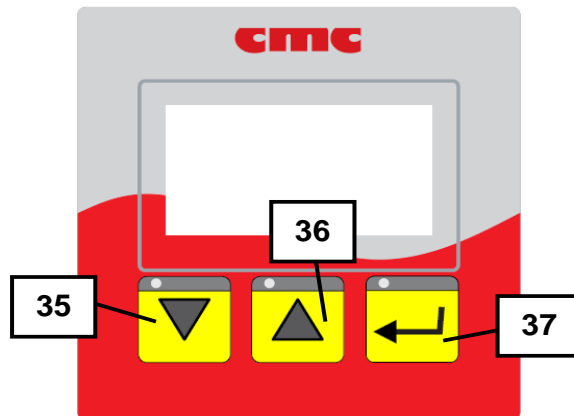

Picture 18: display label.

Command nr.	Operation description
35/36	Selection button of menu options and data
37	Enter menu button

3.3 ▶ Emergency control stations ◀

3.3.1 ▶ Emergency workbench

The emergency workbench (Picture 19) is placed on the left of the turret and it is useful in emergency situations for the recovery of the MEWP aerial part.

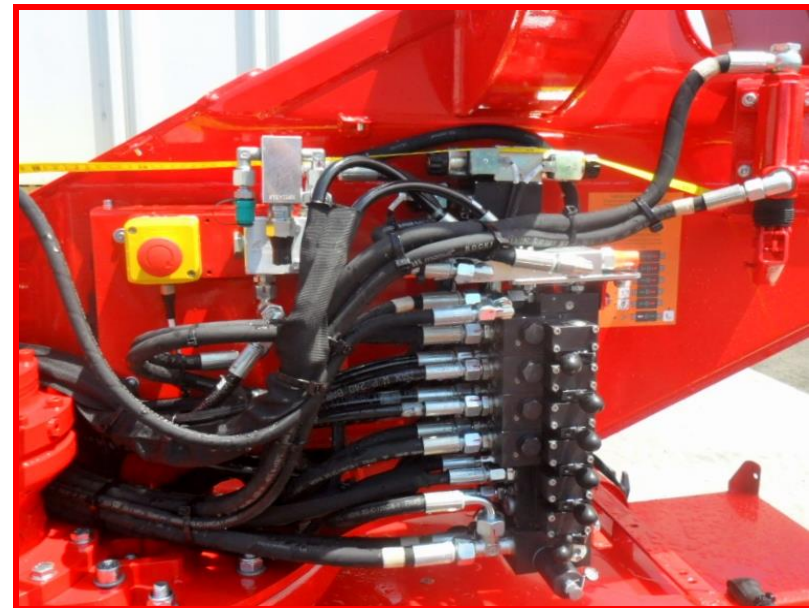

Picture 19: distributor in the emergency workbench.

The functions of the different cursors will be described in the section on the recovery procedures of the aerial part (par. 4.5.3.1).



4 Use procedures

4.1 Environmental operational conditions

The equipment can work normally in the following environmental conditions (for uses in different conditions, a special equipment is required):

- **temperature from -25 °C (-13 °F) to +55 °C (131 °F)** (even +70 °C (158 °F) for short periods which do not exceed 24 h);
- humidity from 30% to 90% (at 20 °C);
- **max wind speed 12,5 m/s (45 Km/h – 27.96 mph).**

Do not cover the equipment with cloths in order to avoid condensation inside the electrical boards.

After storage in closed and very wet places for a long period, the machine could have some problems due to condensation in the electrical boards: in this case, please contact the Technical Assistance Service before use.

 **Do not operate in areas with dangerous environmental conditions:** poor visibility, storms, lightning risk, etc.

 Do not to operate inside refrigerating rooms.

 **Do not operate when the wind speed exceeds 12,5 m/s (45 km/h).** We hereby enclose “Beaufort wind scale” (Table 1):

Wind power		Wind speed		Land conditions
Beaufort number	description	m/s	Km/h	
0	Calm	0-0,2	1	Calm. Smoke rises vertically.
1	Light air	0,3-1,5	1-5	Wind motion visible in smoke.
2	Light breeze	1,6-3,3	6-11	Wind felt on exposed skin. Leaves rustle.
3	Gentle breeze	3,4-5,4	12-19	Leaves and smaller twigs in constant motion.
4	Moderate breeze	5,5-7,9	10-28	Dust and loose paper raised. Small branches begin to move. Dust and loose paper raised. Small branches begin to move.
5	Fresh breeze	8-10,7	29-38	Branches of a moderate size move. Small trees begin to sway.
6	Strong breeze	10,8-13,8	39-49	Large branches in motion. Umbrella use becomes difficult.
7	Near gale	13,9-17,1	50-61	Whole trees in motion. Effort needed to walk against the wind.
8	Gale	17,2-20,2	62-74	Twigs broken from trees. It is difficult to move.
9	Severe gale	20,3-24,4	75-88	Light damages to buildings, tiles removed.
10	Storm	24,5-28,4	>89	Trees are broken off or uprooted, heavy damages to buildings.

Table 1: Beaufort wind scale.



We recommend the use of an anemometer, to determine direction and speed of wind.



Any addition that increases the wind load on the MEWP, such as warning signs, is prohibited.



4.2 ▶ Safety distances ◀

Below there are the safety distances to be kept by qualified staff (alternating current):

Voltage field of electric line	Minimum safety distance
Up to 300 V	Avoid contact
300 V < x > 750 V	1 ft. 0 in. (30,5 cm)
750 V < x > 2 kV	1 ft. 6 in. (46 cm)
2 kV, < x > 15 kV	2 ft. 0 in. (61 cm)
15 kV < x > 37 kV	3 ft. 0 in. (91 cm)
37 kV < x > 87.5 kV	3 ft. 6 in. (107 cm)
87.5 kV < x > 121 kV	4 ft. 0 in. (122 cm)
121 kV < x > 140 kV	4 ft. 6 in. (137 cm)



It is forbidden, in any case, to touch live electrical conductors.

4.3 ▶ Transport, storage and packing ◀

In order to load/unload the platform, it is possible to use a travelling crane of adequate capacity. Sling the MEWP by the proper couplings on the frame (Picture 20).



Picture 20: couplings on the frame.

- ☞ Lifting operations must be carried out when the machine is closed.
- ☞ Be careful not to damage machine.
- ☞ Always use the personal protection equipment; do not handle ropes or chains without gloves.
- ☞ The presence of people in proximity of MEWP during the operations is forbidden.

Alternatively, the load/unload can be done through ramp, exploiting the motricity of the machine as well as its ability to overcome **slopes lower than 19° (34%)**. If you choose this way, please proceed with the following procedure, carefully reading the danger notes suggested.



☞ Comply with the rules in force about width, height, weight and transport speed allowed.
Check that the limit gauge is compatible with the features of the route to be made (i.e. galleries, bridges, electrical and phone lines, etc.).

WARNING! In both cases, it is advisable to remove the basket to favor the operations and reduce encumbrances.

Always use the wired remote control for loading/unloading operations.

4.3.1 ▶ Loading/unloading through ramp

Check that no one is in proximity and that the MEWP is in transport configuration.

In order to ensure a better stability during loading/uploading operations, it is possible to extract the tracks widening the ground encumbrance. To extract the tracks, see par. 3.2.3.

Place the couple of ramps (of adequate dimensions) and bring them in correspondence of the machine tracks.

Check that the ramps attack slope does not exceed 18° (32%) with crawlers opened and not exceed 3° (5%) with crawlers closed. Check they are perfectly clean from grease, mud, snow or ice.

WARNING! Use loading ramps with suitable dimensions and strength. Secure the machine to the truck plane by couplings on the chassis. Ensure that the machine is switched off during the transport.

Travel and climb with the MEWP set as shown in Picture 21: the basket shall always be placed at the rear of the machine.

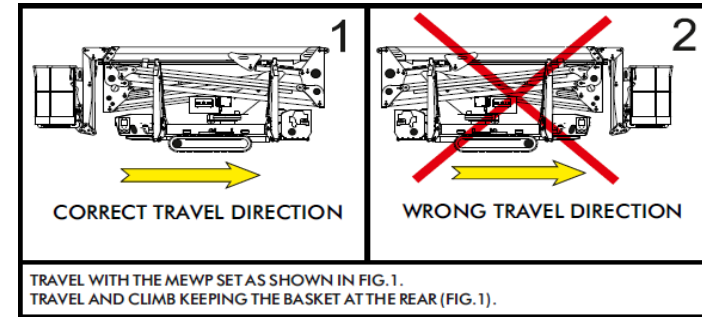

Picture 21: travel direction on the ground.

1. Use the wired remote control.
2. Check that the ramp attack slope to avoid damage to carpentry and that the soil is perfectly clean from grease, mud, snow or ice.

With the purpose of favoring machine loading/unloading through ramp, even if the machine is not stabilized, you can press the parking button **P** (Picture 14) to:

- lift/lower the jib;
- rotate and level the basket.

4.3.2 ▶ Self-loading function

- Drive and then lock the truck, once the load position has been reached;
- stabilize the machine (par. 4.4.2) and use the extensions if present;
- maneuver the truck bringing it from position 1 to position 2;

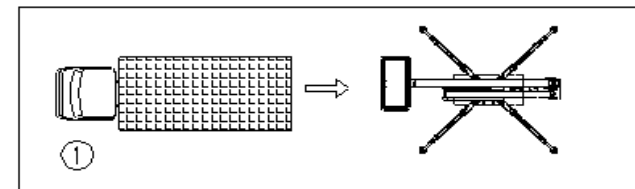

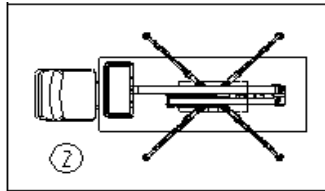

In order to avoid the overturning of the MEWP, use the roll-over control lever 47 (Picture 14), present on wired remote control station: it moves front or rear outriggers closer to the ground.



Do not use the outriggers to lift the transport truck. Stabilizer cylinders could damage irredeemably.

- carry out destabilization by the procedure described in par. 4.4.6 until the configuration 3 is obtained;

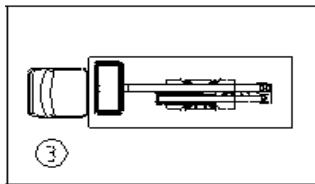

- fix the MEWP to the truck, using the appropriate couplings on the chassis (Picture 20).

Extensible stabilizers for an easier loading of the machine can be supplied as an *optional, in place of the standard ones.

4.3.3 ▶ Travel

The machine, thanks to a variable flow motor, has three levels of speed identified by three different symbols:

- "turtle": minimum speed;
- "hare": average speed;
- "double hare": maximum speed.



Check that no one is in proximity.



In order to ensure a better stability during travel operations, it is possible to extract the tracks widening the ground encumbrance. To extract the tracks, see par. 3.2.1.



WARNING! The hydraulic system through which the triple speed is activated ("double hare") is a serial system. Therefore, it may be necessary to intervene with manual corrections during handling. Be very careful to travel with triple speed!

Travel operations shall be made with the MEWP set as shown in Picture 21: the basket shall always be placed at the rear of the machine.

4.3.3.1 ▶ Travel using wired remote control



Picture 22: speed selector on wired remote control.

In order to perform a travel, using the wired remote control:

1. make sure all outriggers are raised off the ground;
2. make sure the basket lock pin is inserted (Picture 28);
3. make sure the boom groups are returned and supported;
4. turn on the machine (par. 3.1);
5. use the joysticks (Picture 14) to drive the tracks;
6. Position the speed selector **SS** (Picture 22) on the central "turtle" symbol; move it downward to "hare" symbol to increase the tracks speed or upward to "double hare" to reach the maximum speed.



 Check that the travel slope does not exceed the maximum longitudinal limit of 19° - 34% (pre-alarm at 17° - 31%) and the maximum transversal limit of 8° - 14% (pre-alarm at 6° - 11%). Check that the soil is clean from grease, mud, snow or ice.

 Prefer to use the wired remote control for travel operations.

4.3.3.2 ▶ Travel using basket console

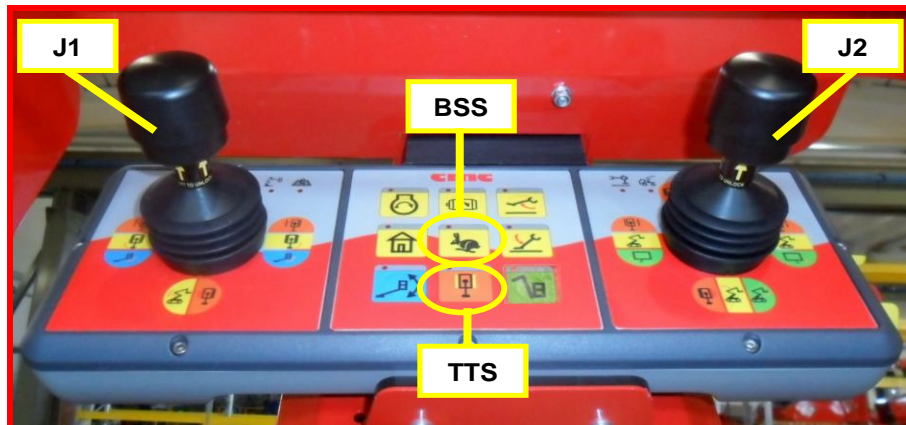

Picture 23: basket console.

The basket control station shown in Picture 23 has:

- **TTS** tracks operations selector: by selecting this button, the movement of the tracks is activated; it is possible to achieve the desired travel through the two joysticks **J1** and **J2**;
- **BSS** speed mode selector: through this lever, you can decrease/increase the travel speed.

In order to perform a travel, using the basket control station:

1. make sure all outriggers are raised off the ground;
2. make sure that the basket block pin is inserted (Picture 28);
3. make sure that the boom groups are perfectly retracted and supported;
4. disable the wired remote/radio control or disconnect it;

5. switch on the machine (par. 3.1);
6. use the joysticks **J1** and **J2** (Picture 23) together **TTS** button to maneuver the tracks;
7. by pressing the speed selector **BSS**, it is possible to increase the speed of the crawlers.

 The travel slope limits are lower from the basket control station: 9° (pre-alarm at 7°) longitudinally and 7° (pre-alarm at 5°) transversally.

 **WARNING!** If the slope is > 9°, the travel must be performed through wired remote control.

Procedure for bypass of the travel block:

During travels, when reaching a pre-alarm slope limit, an intermittent acoustic warning will activate; it becomes a fixed acoustic signal at maximum slope limits in order to indicate the PROHIBITION TO KEEP ON INCREASING INCLINATION FURTHER.

If the operator continues, reaching max allowed level, the machine will inevitably go into total block.

It will be possible to bypass this block ONLY THROUGH OPERATIONS UNDER THE FULL RESPONSIBILITY OF THE USER, who can proceed as below (Picture 24):

1. Reach the electric box on the turret;
2. Remove the lead seal and lift the yellow cup on the right side;



Picture 24: electric box for travel block bypass.

3. Activate the black ON/OFF lever inside.

The bypass, at this point, will be active and the operator will be able to take the machine back to the conditions prior to the block (travel in the original direction), until stopping the previously activated acoustic warning.

C.M.C. DECLINES ANY TYPE OF RESPONSIBILITY TO THE OPERATOR. THE MANUFACTURER HAS CLEARLY ESTABLISHED TWO ACOUSTIC WARNING THRESHOLDS, IN ORDER TO FULLY INFORME THE USER ABOUT THE DANGERS DUE TO THE NON-RECOMMENDED ACHIEVEMENT OF 19° LIMIT.

4.4 ▶ MEWP use procedures ◀

The machine is equipped with the "SCS System" (Self Control System) which allows:

- automatic stabilization,
- automatic speed control,
- automatic closing of the aerial part.



The following procedures shall be carefully carried out in the correct chronologic order.



If full lithium version (*optional), before any work start, check the battery charge level. It is necessary to have at least 75% of battery charge, otherwise it is advisable to charge them before working.

4.4.1 ▶ Placement on the working area

1. Start the endothermic/electrical engine using the supplied engine ignition key (Picture 4).
2. Identify the working area, which is nearest to the working place, and reach it by machine handlings, using travel buttons (par. 4.3.3).

➔ **C.M.C. obligates to use the remote travel controls, in order to ensure the travel operations in complete safety.**

3. Make sure the soil bears the load of the outriggers and check that there are no manholes, floors or other soft structures in the contact point of every stabilizer plate with the ground.



In case there are not such conditions, it is strictly forbidden to use the MEWP.

4. Place the MEWP on the chosen area.
5. Define the working area with appropriate signals (white-red ribbon, white-red chains, cones, etc.).



4.4.2 ▶ MEWP stabilization

The MEWP has different stabilization areas, according to the different combinations of possible stabilizer openings. Each outrigger can be positioned in two different configurations (in addition to the closing one), corresponding to two work areas (Picture 25): one narrow (1) and one wide (2). A double electronic locking system uniquely ensures the chosen work area.



The movement of the outriggers must be possible only when the booms are resting on their supports (transport configuration). This condition causes the stabilization consent light **19** (Picture 12) to light up on the control stations.

- Lift the 4 pins which block the outriggers position. If this operation results difficulty, move the stabilizer trying to rotate it in the horizontal plane during the lifting.



It is forbidden, and unnecessary, to completely remove the pins from their seat.

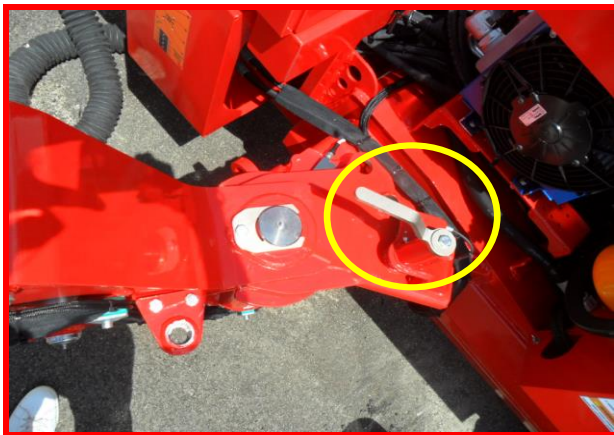

Picture 25: outriggers pin.

- With the pin lifted (Picture 25), rotate the outrigger taking it in a position which allows the reinsertion of the same pin. For each

outrigger, it will be possible to choose two positions (1 or 2): the positions taken by the outriggers determine the working area.

- Once reached one of the two outrigger positions required, push the pin downward until blocking it.



Check the status of cleanliness and integrity of the limit switches in-built in the stabilizers (cursor, bracket, spring, etc.) before the operations described above.



Verify that the maximum slope to stabilize not exceed 16° (29%).

The control station in Picture 15, present on the frame, allows to perform stabilization/destabilization of the machine.



In order to facilitate stabilization of the machine, it is advisable to widen the tracks beyond the shape of the frame. They are adjustable in height and width.

The machine will be correctly stabilized when the consent indicator for the use of the aerial part **20** (Picture 12) will light up. To achieve this condition, it is strictly necessary to lower the outriggers until they are well positioned on the ground, the tracks uplifted and the frame in planarity with a maximum tolerance of 1° (inclinometer control).



It is essential to carry out the stabilization operations by operating on all four buttons simultaneously. Once the feet will all have touched the ground, it will be possible to continue running short alternate cycles before on the two front stabilizers and then on the two rear ones.

4.4.2.1 ▶ Automatic stabilization with wired remote control

If you want to stabilize the machine in automatic mode, you can use the wired remote/radio control:



- use the lever **ASD** (Picture 26). It causes the simultaneous descent of the four outriggers until the switch reads them on the ground and the lifting of the tracks;



Picture 26: stabilization/destabilization lever on wired remote control.

- make sure that the consent indicator for the use of the aerial part **20** (Picture 12) is on.

During stabilization phase, pressing the parking button **P** (Picture 16), together the stabilization lever, you can raise all the machine without waiting the predefined cycle of automatic stabilization.



Always prefer a remote control station.

4.4.2.2 ▶ Automatic stabilization with basket console

The stabilization can also be performed automatically, from the basket console, deactivating the wired remote control:

- by means of the basket control station, it is also possible to perform automatic stabilization/destabilization with the **BASD** buttons (Picture 27).



Picture 27: stabilization/destabilization buttons on basket station control.

- make sure that the consent indicator for the use of the aerial part **20** (Picture 12) is on.

4.4.3 ▶ Basket assembly/disassembly

9. Turn off the machine and proceed with the basket assembly.

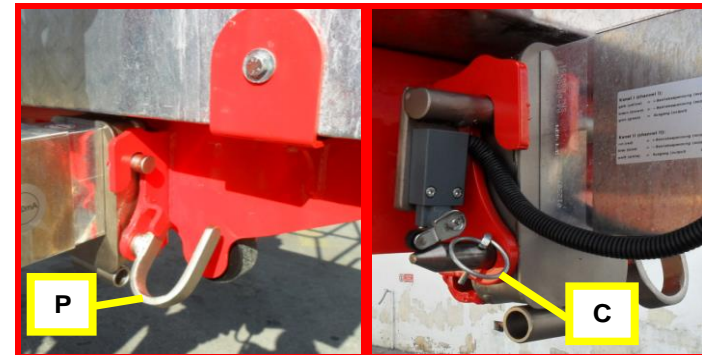

Picture 28: basket coupling.

10. Once the basket is coupled, insert the pin **P** and the safety cotter pin **C** to block it to the jib support (Picture 28).
11. Enter the basket by lifting the self-locking closing bar and using the underlying step; **ensure the bar is back to the closing position;**



fasten the safety harness to the proper eyelets in the basket frame.

-  It is forbidden to overload the basket exceeding its maximum allowed nominal capacity.

4.4.4 ▶ Basket leveling

11. After making sure the light **19** (Picture 12) is on, level the basket using the basket control station (par. 3.2.1): press both the dead man button **16** (Picture 11) and the joystick **J1** lever for basket leveling control, in case the floor is out of level.

-  Level the basket only when the MEWP aerial part is set in the transport configuration.

-  It is strictly forbidden to level the basket with the machine open.

4.4.5 ▶ Use of the aerial part

-  The following procedure should be carried out with the most caution and wearing all personal protective equipment.

12. After making sure the light **20** (Picture 12) is on, using the basket control station, carry out the MEWP aerial part operations by the manipulators described in the paragraph 3.2.1.

-  First lift the upper boom, in order to rise it from the support.

-  It is strictly forbidden to rotate the turret as first movement, since it could seriously damage the carpentry.

-  It is forbidden to enter or exit the work platform at different levels, when the machine is developed.

-  It is forbidden to increase the outreach or working height of the MEWP by using additional equipment.

-  It is forbidden to use the MEWP as a lifting device.

-  Avoid contact of the aerial part with fixed objects (buildings, etc.) or with moving objects (vehicles, lifting equipment, etc.).

4.4.5.1 ▶ Moment limiter

-  Thanks to a moment limiting device (anti-tipping device fitted as standard on these machines), all operations bringing the machine over the working diagram are ineffective.

When the maximum allowable outreach is almost reached (90%), the pre-alarm indicator **6** lights up (Picture 10).

When the maximum allowable outreach is reached (see the working diagram in Picture 2a), the alarm indicator **7** lights up (Picture 10).



4.4.5.2 ▶ Load limiter

-  Moreover, when the MEWP exceeds its maximum permitted capacity (220 Kg), the load cell system (Picture 29) detects the overload and stops the work operations, warning with a continuous acoustic signal.



Picture 29: load cell.

During the movement of the MEWP aerial part, reaching the maximum load selected, the load limiter safety device activates.

- Overload until 20 Kg (signaled by the lighting of the intermittent block light  – Picture 10 and by an intermittent acoustic warning): in this case, operations remain active, even if these two signals warn the user about the danger; the signals will stop only removing the overload from the basket.
- Overload > 20 kg (indicated by the fix lighting of the block light  – Picture 10 and by a continuous acoustic warning): the load limiter safety device stops all operations of the extendable structure: the operator must unload the overload from the basket to reuse the MEWP.

➔ The operator must remove the overload from the basket to continue the work with the MEWP.

 **It is strictly forbidden to use the MEWP when the load limiter device acoustic warning is on. Remove the exceeding load from the basket until the acoustic signal and the relative light go out.**

4.4.5.3 ▶ Slowdown of the aerial part maneuvers

Slowdowns can be set by software for start and end of each aerial part maneuver (lifting/lowering of booms, extension/retraction of booms, clockwise/

anticlockwise rotation of the turret, opening/closing jib), valid in the following conditions:

- Boom angle >x° or <x°;
- Boom extension >x mm or <x mm;
- Opening jib >x mm or <x mm;
- Pre-alarm condition (90% of the block);
- Approaching the turret angle to a curve change zone.

4.4.5.4 ▶ Anti-collision system

Since the machine can also work at negative heights, the anti-collision system supplied prevents the basket and booms from impacting with the outriggers, blocking the activated movements.

However, it is possible to bypass this system by pressing the parking button  on the right side of the wired remote control (Picture 14).

4.4.6 ▶ Setting the MEWP in the transport configuration

13. In order to set the MEWP in the transport configuration, first center the turret, return on the ground the MEWP aerial part, withdrawing the telescopic boom groups, and laying the booms on their supports, using the basket control station (par. 3.2.1).



WARNING! CENTER THE TURRET BEFORE LOWERING BOOMS.

14. Unfasten safety belts and get off the basket using the steps below.

If you want to destabilize the machine:

- by outriggers control station, keep the dead man button 30 pressed and use the button 26-27-28-29 (Picture 16).
- if you want to automatically destabilize the machine, use the lever ASD on the wired remote control (Picture 26).



IT IS ESSENTIAL TO CARRY OUT THE DESTABILIZATION BY OPERATING ON ALL FOUR LEVERS SIMULTANEOUSLY.



With the MEWP stabilized, pressing the parking button **P** on wired remote control (Picture 16), it is possible return the two boom groups.

- At the end, it is possible to restart the MEWP to take it back to the storage place.



If full lithium version*, at the end of the work, always remember to charge batteries.

4.4.7 ▶ “Home” function

When the appropriate button (dead man) "Home", present both on the wired remote control and on the basket control station (Picture 9 and 14), is held pressed, the automatic closing of the aerial part is activated. The following maneuvers must be carried out up to the limit switches in the chronological order indicated below:

- re-entry of second telescopic boom group up to 0°;
- turret rotation in the direction of origin up to 0°;
- descent of first boom group up to 0°;
- descent of all booms up to support.



CAUTION! IF YOU MEET OBSTACLES DURING THE AUTOMATIC CLOSURE OF THE MACHINE, IMMEDIATELY RELEASE THE BUTTON AND PROCEED WITH THE MANUAL MANOEUVRES.

4.4.8 ▶ Acoustic warnings

During the use of the MEWP, it is possible to hear the following acoustic warnings, corresponding to the following signals:

🔊 SOUND	Corresponding to:
Continuous acoustic signal (intermittent in pre-alarm): when exceeding the maximum load allowed.	Load limiter light activated on basket console and on wired remote control.

Continuous acoustic signal (intermittent in pre-alarm): when exceeding the maximum travel inclination allowed.	Maximum travel inclination light activated on basket console and on wired remote control.
--	---

Table 2: acoustic signals.

4.5 ▶ Lithium battery pack recharge (*optional) ◀

For full lithium version (*optional), in order to recharge the battery pack, it will be necessary to stall the machine.

Then operate according to the following procedure:

- switch off the electric engine;
- couple the plug (power line) to the connector on the machine and press the appropriate button of the magnetothermic switch;
- now the batteries will be in charge and the charge progress can be evaluated through the leds on chassis box or on radio control station.





The charge times are:

BATTERY CHARGE	TIME
0% - 80%	4 h
80%-100%	2 h

With a full charge (100%), the 300 Ah Eco-Battery pack is able to perform at least 20 work cycles. A work cycle includes the following sequence of operations:

- 1) stabilization;
- 2) complete machine development;
- 3) complete machine return;
- 4) destabilization.



AT THE END OF EACH WORKING SESSION AND HOWEVER AT LEAST EVERY 15 DAYS, IF THE MEWP IS NOT USED, ABSOLUTELY RECHARGE THE BATTERY PACK.

4.6 ▶ Emergency operations ◀



Before starting the emergency procedures, it could be useful to contact C.M.C. Service.

In case of emergency, the control of the aerial part of the MEWP can be performed by the operator on the ground using the wired remote control.

4.6.1 ▶ Emergency buttons

In case of emergency, push the emergency button: the MEWP engine switches off and all operations are disabled. This button has priority over all other commands.

The emergency button has a mechanical locking device, therefore, to restore normal working conditions, it must be unlocked by turning it clockwise.

On the machine, there are emergency buttons in the following positions:

1. on the right side of the basket control station (Picture 9);
2. on the center of the wired remote control station (Picture 13);
3. on the left side of the stabilizers control station (Picture 15);
4. on the left side of the turret distributor (Picture 19).

4.6.2 ▶ Emergency bypass

In case the basket operator pressed the emergency button and were unable to reset this button at the original position (due to blackout, fainting or other), it will be possible to disable that safety function through the “**emergency bypass**” **under the red cup** (Picture 30) on the electric box mounted on the chassis.

The ground operator removes a safety lead seal and disable the emergency through **an internal on/off lever**.

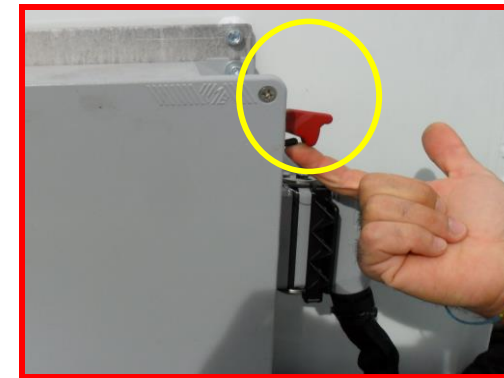

Picture 30: emergency bypass lever.



It will be care and responsibility of the operators, at the end of the operations, to reset the original conditions, including the resealing with seal compulsorily branded “C.M.C.”.

4.6.3 ▶ Emergency procedure in case of electrical system failure

In case of failure of the electrical system (PLC breakdown, but standard engine still working), the machine will go into lockout and the activated error codes will be shown on the remote control display.

☞ Remember that the machine is considered in the working position with the basket on the rear.

In order to secure the machine, perform the following procedures in the indicated chronological order:

1. recovery of the aerial part (including levelling and rotation of basket);
2. closing of the outriggers;
3. narrowing and travel of the tracks.

4.6.3.1 ► Recovery of the aerial part

Unseal and screw the platform electrovalve (Picture 31), placed on the left side of machine to enable aerial part recovery maneuvers.

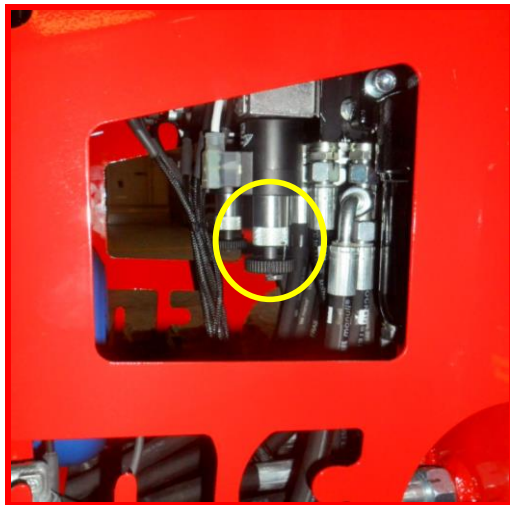

Picture 31: platform electrovalve.

The ground operator has to:

- reach the main inlet group (Picture 32) on the frame and remove the carter;

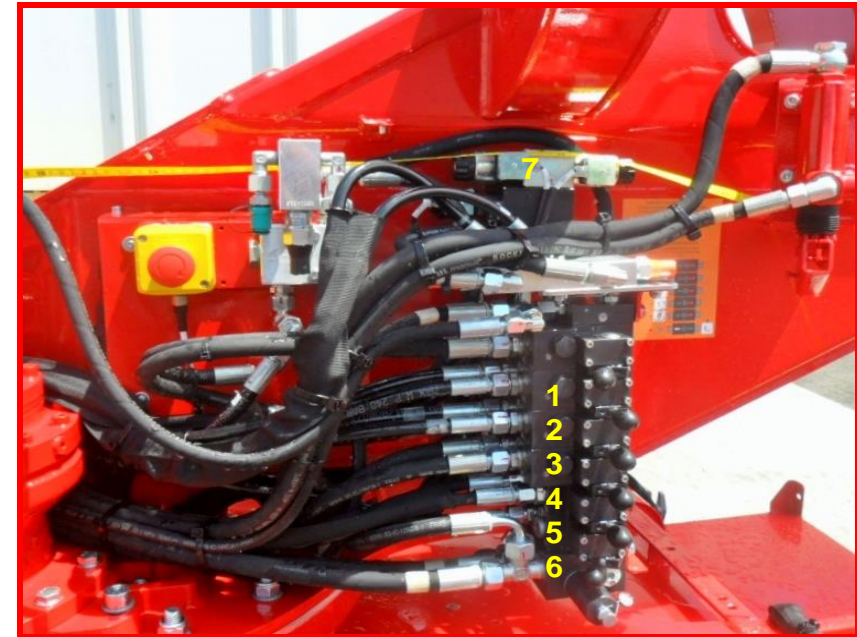

Picture 32: view of main inlet group.

- execute the following operations in chronological order, keeping the **proportional lever 6** at the bottom at the left side:
 - move to the left the lever **1** on the top to retract the second boom;
 - move to the left the lever **3** to retract the first boom;
 - move to the left the lever **4** to lower the first boom;
 - move to the left the lever **2** to lower the second boom.



First carry out the recovery operations of the basket, to make the operator on board safe.

During aerial part return operations, the operators should also carry out the levelling and the rotation of the basket:



- One moves the **proportional lever 6** to the right to consent jib movements and basket rotation; another operator can execute them by basket workbench (Picture 33):
 - press the cursors on the basket left side to rotate counterclockwise the basket and to lower the jib,
 - press the cursors on the basket right side to rotate clockwise the basket and to lift the jib;



Picture 33: basket workbench.

- approaching with a pointed object to the blue cursor at the top of the main inlet group (Picture 34), keep it pressed while pressing the cursors of valve **7**: at left side to perform external leveling of the basket and at the right side for internal leveling;

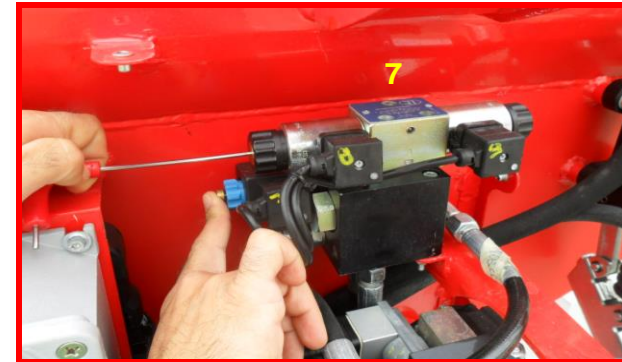

Picture 34: leveling valve 7.

- move the lever **5** (Picture 32) at the left to rotate counterclockwise the turret or at the right to rotate it clockwise.



While return the MEWP in rest configuration, the deceleration speed ramps of the maneuvers will be inactive: therefore, pay particular attention to the operations wearing all personal protection equipment provided.



At this point, it is possible to get the operators off the basket.

4.6.3.2 ▶ Closing of the outriggers

Unseal and screw the outriggers electrovalve (Picture 35) placed on the right side of machine to enable stabilizers recovery maneuvers.



Picture 35: outriggers electrovalve.

Then the ground operator has to reach the outriggers workbench (Picture 36), placed on the right side of the machine, to execute the destabilization.

Describing the cursors from the top to the bottom:

- pressing the first cursor, it is possible to lift the left rear outrigger,
- pressing the second cursor, he can lift the right rear outrigger,
- pressing the third cursor, it is possible to lift the right front outrigger,
- pressing the fourth cursor, he can lift the left front one.

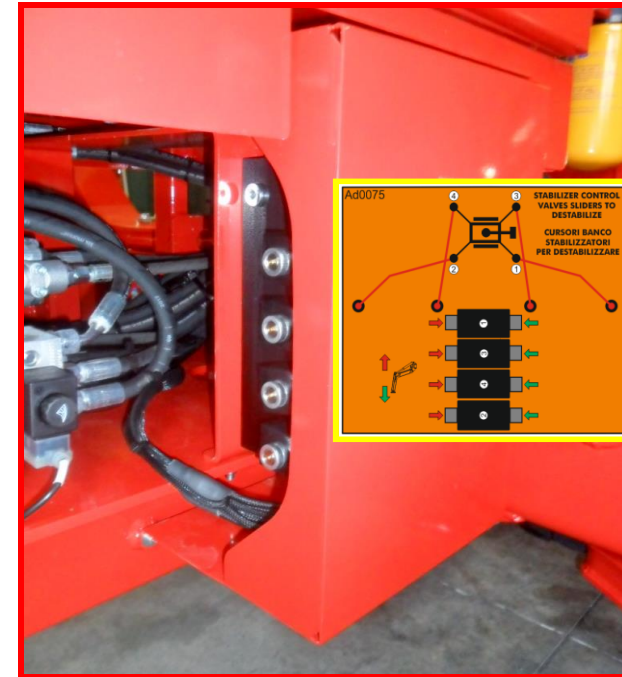

Picture 36: outriggers workbench.

4.6.3.3 ▶ Tracks handling

Unseal and screw the crawlers electrovalves (Picture 37), placed on the right side of machine, to enable tracks recovery maneuvers:

- the left one corresponding to the left crawler;
- the right one corresponding to the right crawler.

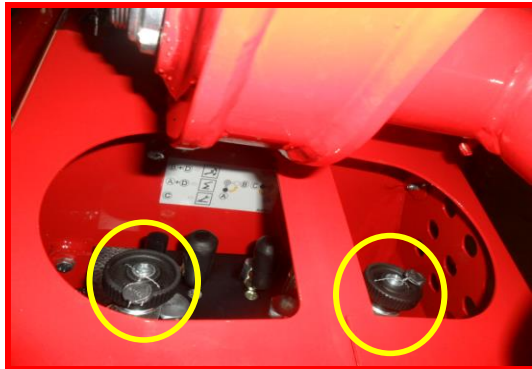

Picture 37: crawlers electrovalves.

Then the ground operator has to reach the travel workbench (Picture 38), placed on the right side of the machine:



Picture 38: travel workbench.

- pressing the cursor **RB**, the right crawler travel backward,
- pressing the cursor **LB**, the left crawler travel backward,
- pressing the cursor **RF**, the right crawler travel forward,
- pressing the cursor **LF**, the left crawler travel forward.

➔ At the end of operations, the operators must restore the valves to their original condition.

⊘ It is strictly forbidden to use the MEWP with solenoid valves tampered or without seals.

4.6.4 ▶ Emergency procedure in case of endothermic engine failure

In case of failure of endothermic engine (engine anomaly, fuel exhaustion, etc.), in order to pressurize the oil in the hydraulic circuit, it is possible to use alternatively:

- the 230/380 V auxiliary electrical engine *optional (par. 3.1.2);
- the emergency electropump *optional (par. 4.5.6);
- the manual pump (par. 4.5.5).

4.6.5 ▶ Emergency procedure in case of electrical and hydraulic system (use of manual pump)

In the unlikely case of concurrent electrical and hydraulic failure (engine malfunction and absence of electropump, electropump failure, etc.), it will be necessary to send oil to the circuit through the manual pump, inserting the lever provided into the appropriate attack on the turret (Picture 39).



Picture 39: manual pump.

Reach the filters workbench on the turret, below the first booms group (Picture 40).

Before starting the recovery of the aerial part, turn the double tap on the **A + D** positions, as indicated by the marking applied near them (Picture 40). Then perform the aerial part recovery as described in paragraph 4.5.3.1.

If it is necessary to operate the leveling, the taps shall be placed in **B + D** positions, as shown on the proper label (Picture 40).

Before starting the outriggers recovery, move the right tap on the **C** position, as indicated by the appropriate marking applied (Picture 40). Then perform the outriggers recovery as described in paragraph 4.5.3.2.

Finally, re-entry the tracks (par. 4.5.3.3) and park the machine.

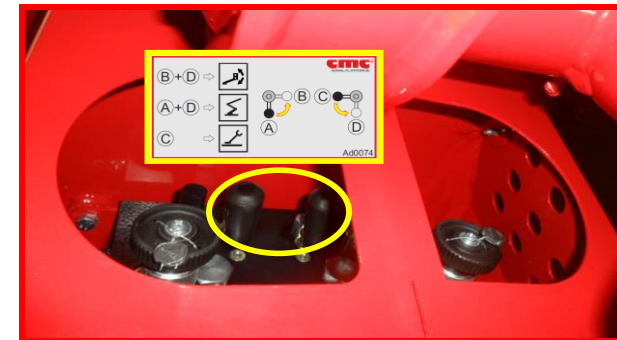

Picture 40: manual pump taps.



It is strictly forbidden to use the MEWP with solenoid valves tampered or without seals.



It is mandatory to restore the sealings after use of these items.



After closing the platform, take it to the nearest Service Center for the restoring of the normal operating conditions which are indispensable for a safety use of the machine.



4.6.6 ▶ Electropump (*optional)

The emergency electropump (24 V) is an alternative energy source for the machine engine.



It is to be used only in case of emergency. Every different use is not recommended because it can produce unexpected discharge of batteries, absorbing current directly from them.



Picture 41: electropump (*optional) activation buttons.

If installed, the emergency electropump can be activated (powered) by pressing appropriate buttons (Picture 41):

- on the left side of travel box (Picture 24);
- on the basket box (Picture 9).

In case of emergency, switch on the electropump and repeat the emergency maneuvers described above (par. 4.5.3), after turning the electropump tap (Picture 42), first to the bottom to recovery the aerial part and then to the top to recovery the outriggers.

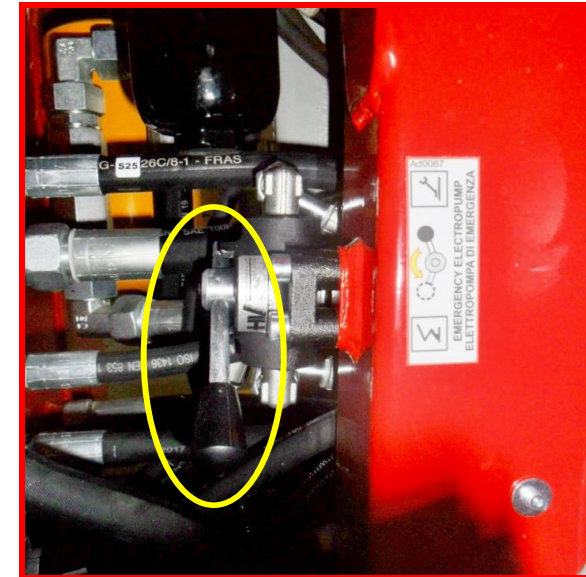

Picture 42: emergency electropump tap.

4.7 ▶ Safety rules



THE NON-COMPLIANCE WITH ANY OF THE FOLLOWING SAFETY RULES, MAY CAUSE SERIOUS DAMAGES TO PEOPLE, THINGS AND PARTS OF THE EQUIPMENT OR THE MACHINE.

4.7.1 ▶ Before and during the movements with MEWP in transport position







It is forbidden to rent the MEWP without non-trained operators and staff.





The hirer is responsible for the training of his operators and of the staff renting the MEWP. C.M.C. s.r.l. declines any responsibility coming from





damages to people and/or things due to the inexperience of these operators;



-  Do not use the MEWP under drug or alcohol effect;
-  Do not use the MEWP under stress conditions;
-  Do not use the MEWP if you suffer from dizzy spells;
- ➔ Before driving, check the tires wear state and the correct inflation pressure;
- ➔ Drive with caution, respecting the highway code;
- ➔ Take the MEWP height overall dimensions into consideration during circulation, in order to avoid clashing against bridges, galleries, underpasses and other obstacles;
-  Do not use the MEWP to perform drawing or pushing operations;
-  Do not use the MEWP as an off-road vehicle;

4.7.2 ▶ Before positioning the MEWP

- ➔ Carefully and chronologically follow the instructions given in this manual;
-  Use the MEWP only with the environmental operating conditions indicated in paragraph 4.1;
- ➔ **Check that the staff allowed to use the MEWP is skilled and trained, and that they know the MEWP use and maintenance rules;**
- ➔ Check that the safety devices are working and efficient; some components (outriggers integrated groups, max pressure valve on the turret), important for the MEWP safety, are calibrated in C.M.C. plants and the containers are sealed before delivering of the MEWP to the customer.
-  It is strictly forbidden to tamper with such components. The absence of the sealing within the machine warranty terms causes the immediate retraction of the warranty as well as the accountability – by the user – of the liabilities coming from an incorrect functioning of the safety devices.

-  Do not remove or modify safety devices;
-  It is forbidden to modify, remove or replace any MEWP component (ballasts, tires, batteries, spare tire etc.): this operation could reduce the machine weight thus impairing its stability;
- ➔ Wear all the protective cloths and the personal safety devices: helmets, safety shoes and - according to the type of work - gloves, hearing protections, respirators, etc.;
-  Do not use clothes with hanging flaps, scarves, ties or any other accessory which could be dragged into the moving parts; inform about the closest fire-extinguishers and first-aid kit.

4.7.3 ▶ During the positioning of the MEWP

-  It is forbidden to operate in situations which are dangerous for the safety of people;
-  Do not operate in explosion hazard areas;
- ➔ Check that the working area is suitable to the MEWP performances and operations, and that it is enough lit;
- ➔ Check that the operational stands and the working area are enough lit and well visible;
- ➔ If operating in closed or little aired environment, ensure, before starting the machine engine, that his has appropriate ventilation or convey exhaust gases outside:
-  Exhaust emissions produced by the MEWP engine are toxic;
- ➔ Appropriately define the working area through suitable signs; observe the laws in force about the traffic, in case you use the MEWP where road circulation is allowed;
- ➔ Check that nobody is within the MEWP action range.
- ➔ Stabilize the truck through the outriggers.



Pay the utmost attention during stabilization: check that no one is inside the stabilization area.

→ Check that the outriggers rest on a non-soft, solid ground that bears the load indicated on each stabilizer.

→ In case of soft ground, use supporting plates.



It is forbidden to place the outriggers on ground roughness: they could be damaged.

→ Level the machine in order to operate on a horizontal plane: max frame inclination 1° - max slope which can be assimilated by the ground 3°.

4.7.4 ▶ During the entrance in the basket



It is absolutely forbidden to use the equipment with loads different from those indicated on the diagram or for uses which are not allowed;



Do not overload the MEWP;

→ **During the different working operations, the use of the safety belts is compulsory.** Do not fasten the safety belts to external structures but only to the supplied grips placed in the basket;

→ Make sure that the bar lifted to enter the basket, has returned in its lock position.

4.7.5 ▶ During the use of the MEWP

→ In any dangerous or irregular conditions, stop the machine by using the emergency button. Before restarting the machine, check that the dangerous conditions are over;



It is strictly forbidden to level the basket when the machine is in working position;



Do not operate when the MEWP is in failure;



It is forbidden to use the “platform control (emergency) position” when there are operators inside the basket, unless there is emergency or for testing operations before starting the work (which shall be carried out without anyone in the basket): from downstairs, it is difficult to estimate how far the basket and the MEWP structure components are from possible obstacles;

→ Follow the MEWP working diagram.;



It is strictly forbidden to use the platform as a crane, to hang posters, banners, poles, etc. to the basket or to any other part of the MEWP.;



Do not connect chain or ropes to the MEWP (since they could be trapped amongst the MEWP moving parts or they could hook fixed objects thus causing the machine overturn);



It is absolutely forbidden to lift or lower loads by using ropes and pulleys;



It is forbidden to lean out;



It is forbidden to use the MEWP for recreational purposes;



Do not perform the basket rotation operation together with other operations;



No material shall fall from above: fasten the working material properly;











Do not throw objects (tools) upside down or vice versa.





In case of works like pruning, plants maintenance, etc., it is forbidden to let trunks, pipes, poles etc. fall inside the basket or on the MEWP structure: they can severely impair the MEWP stability;

→ During works like paintings, etc., protect yourselves and the machine;



-  It is strictly forbidden to put tools, body parts in the areas marked by the stickers indicating crushing, shearing hazard; keep hands away from any hole or slit;
-  It is forbidden to use tools not complying with the laws in force;
- ➔ When working at low temperatures, it is necessary to perform some in-vain operation so that the hydraulic circuit oil reaches the operating temperature;
-  It is forbidden to let people walk or stay within the MEWP working area;
-  It is forbidden to stay on the counter frame floor, during MEWP operations.
- ➔ Firmly cling to the work platform during lift and descent;
- ➔ Controls shall be started by slow and gradual movements:
-  Do not operate controls swiftly and suddenly
-  It is forbidden to make the platform swing;
- ➔ Check the MEWP stability during all the operations phases;
- ➔ Do not move the MEWP during the working operations;
- ➔ Keep enough safety distance from the obstacles: avoid contacts with fixed (buildings, etc.) and moving (vehicles, cranes, etc.) objects, with the truck cabin, with the outriggers and with other structure parts;
-  It is forbidden to use ladders or tables on the basket in order to increase the MEWP outreach or working height;
- ➔ Be careful when working in close buildings: due to the “wind tunnel” effect, sudden blasts could cause swinging, thus impairing the machine stability;
-  It is forbidden to lift “full surface” panels (signs, advertising panels, boards, etc.): these could cause the “sail” effect;
-  It is forbidden to leave the MEWP unattended when it is in working position;

-  It is forbidden to exceed the max number of basket operators allowed;
-  During the normal use of the platform, it is absolutely forbidden to use electronic instruments which do not meet the requirements of the directive 72/245/CE and its following amendments: the additional electronic instruments could impair good functioning of the platform electronic components.

4.7.6 ▶ At the end of the works

- ➔ Before moving the machine, check that the MEWP aerial part is set in the transport position: telescopic booms withdrawn and rested on them support;
- ➔ Before moving the machine, check that the outriggers are completely withdrawn and lifted.

4.8 ▶ Safety devices

- ➔ **The machine is equipped with safety devices designed to prevent the occurrence of dangerous situations for the operator. Before starting any operation, it is important that the operator checks the perfect functioning of these devices.**



The non-functioning of a safety device, caused by a failure or tampering, can cause serious injury damage to the machine and consequently endanger life operator. The manufacturer has designed the machine and its devices in order to guarantee the maximum safety for its customers; however, the devices must be checked periodically as described in this manual and must never be tampered with.



Do not intervene on your own safety devices. In case of tampering, the manufacturer declines all responsibility about any accidents attributable to these interventions.



In case you notice non-functioning of a safety device, ask for help to C.M.C. Service.

The following are the safety devices available to the user, in order to understand the behavior of the machine and the possible work sequences:

➔ **Electrical/electronic devices:**

- Removable key for the MEWP start;
- Emergency stop buttons, mechanically blocked, on all control stations;
- Microswitch blocking the outriggers controls with booms lifted and if the extension is not in withdrawn position;
- Microswitch for outriggers end-of-stroke;
- Outriggers pins microswitches;
- Overload protection fuses against brownout, both on the power circuit and on the control circuit;
- Basket levelling maneuver only allowed when the MEWP aerial part is in rest position (telescopic boom on its support);
- All machine controls hold-to-run;
- Interlock stabilizers-boom maneuver:
 - block of the manoeuvres of the MEWP aerial part when this is not stabilized;
 - block of the manoeuvres of stabilizers return/extraction when the MEWP aerial part is not in rest position.
- Warning light - machine stabilized;
- Warning light - electrical supply of the MEWP;
- Warning light – consensus for aerial part use;
- Moment limiter device;
- Load limiter device;
- Inclinator;
- Anti-collision system;
- Emergency bypass;
- Engine stop bypass;
- Travel block bypass;
- Electropump*.

➔ **Hydraulic devices:**

- Pressure relief valves for the protection of the entire hydraulic circuit and the individual parts of the system.
- Block valve and parachute valve mounted on the lifting cylinders;

- Manual pump for emergency operations;
- Oil flow adjuster for the control of the descent speed.

➔ **Mechanical devices:**

- Hydraulically controlled negative disc brakes;
- 1,10 m height border guardrail on the basket;
- Mobile bar for access to the basket with gravity closing;
- Basket with safety belts anchorages;
- Mechanical blocking system of turret rotation;
- Limit switch on boom 1 and 2 lowering in transport position;
- Limit switch on stabilizers opening;
- Safety control on extension chains of boom 1;
- Safety control on extension/return chains of boom 2;
- Protective carter over control stations.
- Air bubble level.
- Screws and nuts for locking pins.



All safety devices could wear out and lose their calibration, it is therefore necessary to control and keep them in perfect working order.

Do not rely totally on these devices to assess your working and safety conditions; in any case, the operator must have a proper and conscious use of the machine.

5 ▶▶ Markings ◀◀

On the machine there are the following markings.

- ➔ Before using the MEWP, it is compulsory to check the presence and the perfect readability of these marks. In case of absence or decay of the marks, contact the Service.

 C.M.C. s.r.l. Via Bitritto, 119 701 24 BARI - ITALY Tel. 080 5326606/557 http://www.cmclift.com E-mail: info@cmclift.com				
TYPE		S32	MANUFACTURER	CMC
MODEL		S32	YEAR	
SERIAL NR.		TOT. WEIGHT		lbs
CAPACITY	486 lbs	INCLUDING	2 persons	
MAX HYDRAULIC OPERATING PRESSURE		3336 PSI		
MAX MANUAL HORIZONTAL FORCE ALLOWED		90 lbs		
MAX WIND SPEED ALLOWED		28 mph		
MAX FRAME INCLINATION ALLOWED		1°		
EXTERNAL POWER SOURCE		120 V	60 Hz	

Picture 43: identification plate (fac-simile).



Picture 44: CMC machine marking.

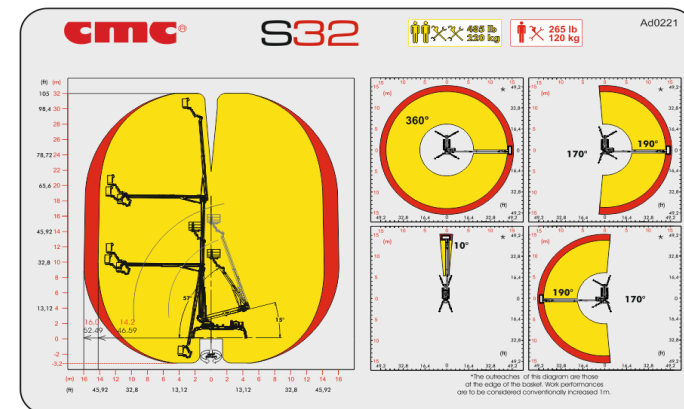

Picture 45: work diagram.

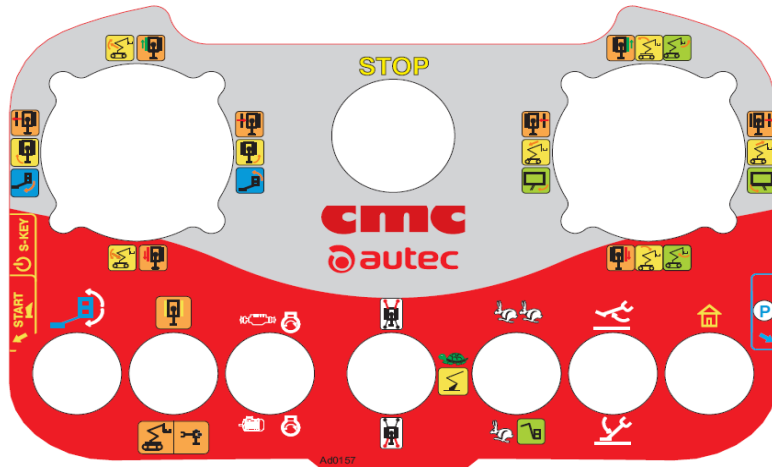

Picture 46: AUTEC wired remote control.



Picture 47: MOBA basket control station.

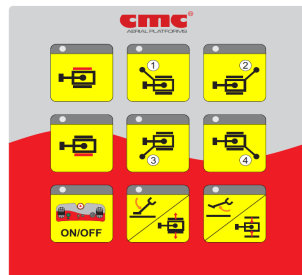

Picture 48: outriggers control station.

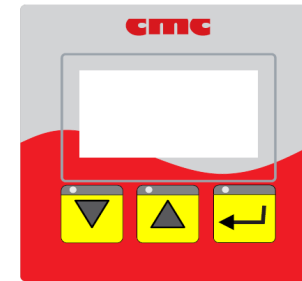

Picture 49: display label.

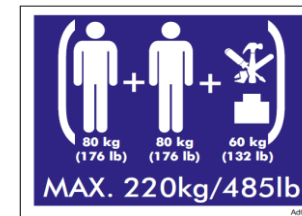

Picture 50: max capacity allowed in the basket.



Picture 51: load cell marking.



Picture 52: safety belt attachment point.



Picture 53: indication of air/water supplies.



Picture 54: indication of 24 V socket.

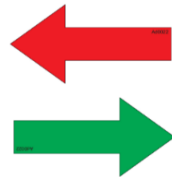

Picture 55: travel directions on tracks.

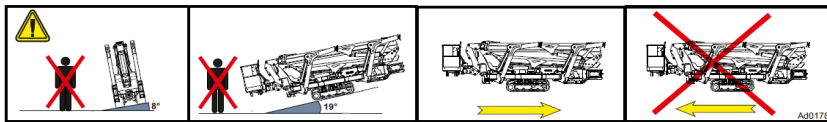

Picture 56: maximum slopes for travel.

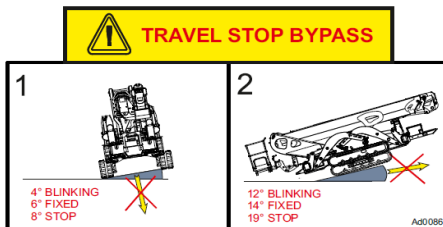

Picture 57: travel block bypass.



Picture 58: use and maintenance manual box.

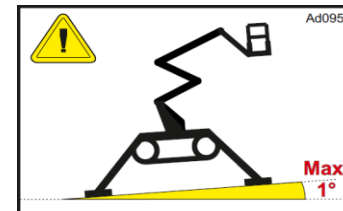

Picture 59: indication of maximum frame inclination.

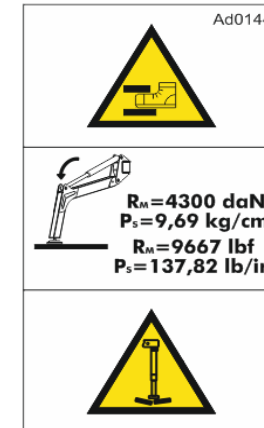

Picture 60: maximum load on stabilizers.



Picture 61: prohibition to stand in work area.



Picture 62: prohibition to remove safety devices.



Picture 63: indication for fuel refill.



Picture 64: exhaust gas hazard.



Picture 65: danger of flammable substances.



Picture 66: indication for grease application.

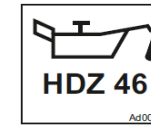

Picture 67: indication for engine oil checking/refill.

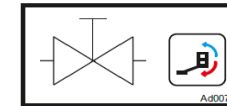

Picture 68: indication of basket levelling valves.



Picture 69: auxiliary electric engines.

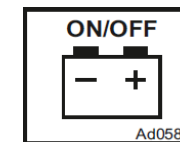

Picture 70: indication for engine battery disconnection.

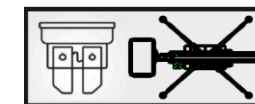

Picture 71: indication of platform fuse.



Picture 72: indication of frame coupling.



Picture 73: indication of fork points.

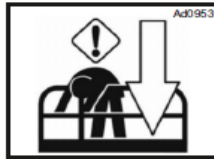

Picture 74: warning for basket operator fainting.

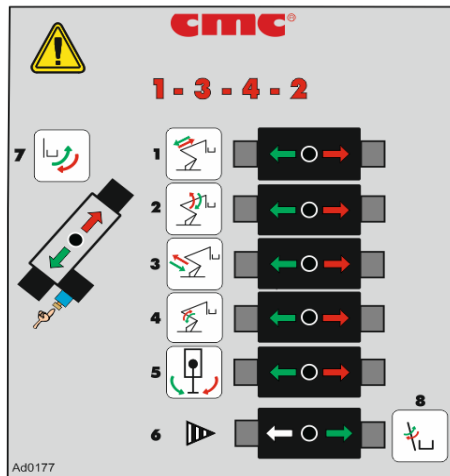

Picture 75: emergency workbench on turret.

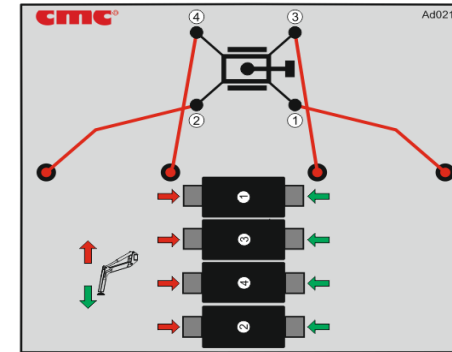

Picture 76: outriggers control station.



Picture 77: emergency bypass.



Picture 78: indication of emergency manual pump.

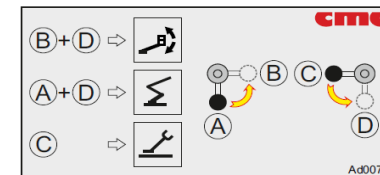

Picture 79: aerial part/stabilizers exchange tap in case of manual pump.

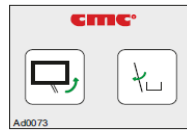

Picture 80: electrovalve for basket rotation/leveling.



Picture 81: general obligations and prohibitions.

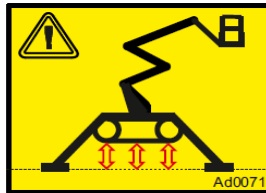

Picture 82: warning for tracks lifting during stabilization.



Picture 83: warning of burn risk.



Picture 84: earthing.



Picture 85: electric danger.



Picture 86: crushing and cutting hazard.



Picture 87: high pressure hazard.



Picture 88: danger of falling.



Picture 89: obstacle danger.



Picture 90: machine sound power.



Picture 91: prohibition to wet the machine.



Picture 92: warning to obligate to the consultation of use and maintenance manual.

GUIDELINES FOR USE AND MAINTENANCE

- The use of the MEWP is restricted only to authorized and previously trained personnel.
- Consult and comply strictly with the instructions indicated in USE AND MAINTENANCE MANUAL attached to the machine.
- Never exceed the maximum capacity indicated on the basket.
- The use of personal protective equipment is mandatory. In the basket, hook the safety belt to the appropriate anchors.
- Before starting works, the operator must make sure that the mechanical parts and safety devices work properly and efficiently, and check the hydraulic oil and fuel levels.
- Never stabilize the machine on soft, accidental, slippery ground or with slopes higher than the allowed limit.
- Perfectly level the machine frame within the maximum allowed limit.
- All handling maneuvers must be carried out making sure that you have complete visibility of the work area.
- Before activating any movement, check that there are no obstacles or people in the work area.
- Load and unload from the basket only on the ground.
- It is forbidden to carry out works at a distance of less than 5 m from power lines.
- It is forbidden to operate in unfavorable weather conditions.
- It is forbidden to use the machine as a lift for things or people.
- It is forbidden to fix stairs or other equipment to the basket to increase the working height.

Ad0137

Picture 93: MEWP use guidelines.

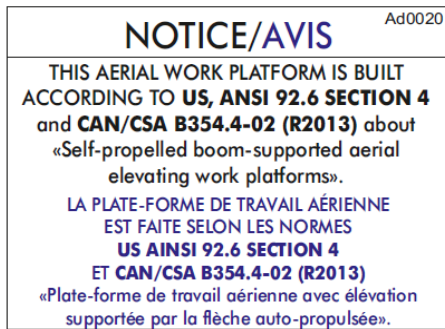

Picture 94: compliance with ANSI and CAN/CSA rules.



Picture 95: inspection tag.



6 ▶▶ Electrical system ◀◀

The MEWP is electrically supplied when the key is inserted and rotated in position 1 (Picture 4).

The electrical system is attached to this manual.

Periodically check the efficiency of the electric scheme: batteries, alternator, charge alternator regulator.



Any operation, requiring interventions on the components of the machine, shall be carried out by authorized and trained staff.



It is forbidden to replace the components for non-authorized staff. **Many components of the MEWP have been calibrated: a correct calibration of these parts (which is possible only in C.M.C. or in authorized Services) is important to assure the safety of the machine.**



7 ▶▶ Hydraulic system ◀◀

The MEWP hydraulic system is attached to the manual.

The pressure setting of the relief valves must correspond to the following values:

Data	Value	Unit of measure
Filters group workbench	3480 (240)	psi (bar)
Platform distributor	3480 (240)	psi (bar)
Outriggers distributor	3626 (250)	psi (bar)
Tracks distributor	2900 (200)	psi (bar)
Basket bench	3191 (220)	psi (bar)
Basket levelling valve	2900 (200)	psi (bar)
Travel workbench	2900 (200)	psi (bar)
Engine displacement change	435 (30)	psi (bar)

A radiator for cooling the hydraulic circuit oil and a biodegradable hydraulic oil can be provided as *optional. In case of its refill or replacement, it is imperative to comply with the technical specifications of the product already present in the system.

To check these pressure settings, it is necessary to be equipped with a manometer.

Make sure that the machine is closed and in the rest position and that nobody is present in the machine's operating range.

Visually inspect all hoses, fittings and all other components of the hydraulic system in order to identify any possible leaks.

Normally, leaks on the pipes can be eliminated by correctly tightening the fittings. If leaks in the sealing areas (o-rings, sealing rings, etc.), the restoration of the seal can only be carried out by replacing the gasket.



All the operations requiring the intervention on the components of the machine, shall be carried out by authorized and trained technical staff.



Non-authorized staff shall not replace any of the components. **Many components have been calibrated: a correct calibration of these parts (possible only in C.M.C. or in authorized Services) is necessary to ensure the safety of the machine.**



8 Maintenance

Working in safety also means working with equipment in accordance with law standards and under constant control.

Then, the employer must:

- select proper equipment, adapted to the environment and working conditions and to the characteristics of the worker who implements it;
- supervise that it is used appropriately, and that specific training is provided to workers;
- ensure that the work equipment is:
 - installed and used in accordance with the use instructions;
 - subject to proper maintenance in order to guarantee the permanence of the safety requirements
 - subject to the update of the minimum safety requirements proved with international specific regulations.

A correct use of the platform and a regular maintenance are crucial to keep it always in the best working, efficiency and safety conditions. The frequent washing of the equipment by high-pressure water jet machines is crucial to get rid of the harmful remains coming from the works performed and from atmospheric agents. Before washing, set the MEWP in driving position, stall the engine and take off the batteries.

In order to document what has been done, the employer is therefore required to draw up and update the appropriate equipment control register.



Carefully read and scrupulously follow the maintenance instructions and safety laws during the maintenance.

The operations indicated with **USER** are to be performed by the user. The operations indicated with **C.M.C.** shall be performed only by C.M.C. srl or in authorized repair shops. Use only C.M.C. original spare parts (even if on the market there are equivalent or similar parts).

The frequency of the maintenances is indicated in every table. It is implied a normal use of the equipment; while, for particularly rough uses or in harmful environments (presence of dust, sand, etc.), an optimal maintenance frequency is left to the good sense of the user.



If an intervention that is different from the following ones is necessary, ask the Technical Assistance Service for authorization and instructions.

8.1 Daily maintenance



Every day, before starting the MEWP, perform what follows:





All the following checks are to be performed operating the MEWP from the emergency position and without anyone inside the basket.





Checks by USER	In case of negative result of the checks:	Intervention by:
Check the level of the hydraulic oil in the tank.	Top up	USER
Check the level of the gas-oil in the tank.	Top up	USER
Check the level of the refrigerating liquid.	Top up	USER
Check the batteries* charge condition.	Charge or replace	USER
Check the cleanliness of the floor: oily or greasy residues could cause slipping.	Clean	USER
Check the wholeness of the instruction and warning stickers.	Replace and/or integrate	USER



Checks by USER	In case of negative result of the checks:	Intervention by:
<p>Perform the following test maneuvers operating on the (emergency) controls of the cabled remote control when no one is aboard:</p> <ul style="list-style-type: none"> ○ Lifting and lowering of telescopic boom 1; ○ Lifting and lowering of telescopic boom 2; ○ Lifting and lowering of the Jib; ○ Turret CW and CCW rotation; ○ Extension and withdrawal of telescopic booms. 	 If the problem can be solved following the instructions given in the paragraph "Trouble shooting", perform the operations indicated in the said paragraph.	USER
<p>During the test operations, check that the basket floors stays horizontal.</p> <p>Check the functioning of the outriggers block valves, with boom not in the rest position:</p> <ul style="list-style-type: none"> ○ Extend outriggers and level the MEWP; ○ Push the "EMERGENCY" button to stall the engine; ○ Operate the lever for the lift and lowering of the outriggers. <p>OUTRIGGERS SHALL NOT MOVE.</p>	 If the problem is not solvable following the instructions indicated in the paragraph "Troubleshooting", it is strictly forbidden to use the MEWP. Contact the Service.	C.M.C.

Checks by USER	In case of negative result of the checks:	Intervention by:
<p>Check the functioning of the block valves of the boom extension cylinder:</p> <ul style="list-style-type: none"> ○ Extend the boom and set it vertically; ○ Push the "EMERGENCY" button to stall the engine; ○ Operate the extension and retraction lever of extension boom. <p>THE BOOM SHALL NOT GET BACK IN.</p>	 If the problem can be solved following the instructions given in the paragraph "Trouble shooting", perform the operations indicated in the said paragraph.	USER
<p>Check the functioning of the block valves of the boom lifting cylinder:</p> <ul style="list-style-type: none"> ○ Load the basket with 220 kg (only weights).  During the test, it is strictly forbidden to load the MEWP with people in the basket. <ul style="list-style-type: none"> ○ Extend the telescopic boom; ○ Push the "EMERGENCY" button to stall the engine; ○ Operate the lifting and lowering lever of the telescopic boom. <p>THE TELESCOPIC BOOM SHALL NOT MOVE.</p>	 If the problem is not solvable following the instructions indicated in the paragraph "Troubleshooting", it is strictly forbidden to use the MEWP. Contact the Service.	C.M.C.



Checks by USER	In case of negative result of the checks:	Intervention by:
Check the absence of splits, cracks, rust on the MEWP structure.	 It is strictly forbidden to use the MEWP. Contact the Service.	C.M.C.
Check that the safety devices (emergency buttons, interlock system for outriggers-boom) work perfectly.	 It is strictly forbidden to use the MEWP. Contact the Service.	C.M.C.
Check that the controls, the pilot lights, the emergency buttons work perfectly.	 It is strictly forbidden to use the MEWP. Contact the Service.	C.M.C.
Check the wholeness of the cable chains.	 It is strictly forbidden to use the MEWP. Contact the Service.	C.M.C.
Check that the blocking systems (pins, locknut, etc.) are in perfect condition and efficient.	 It is strictly forbidden to use the MEWP. Contact the Service.	C.M.C.

Checks by USER	In case of negative result of the checks:	Intervention by:
Check the wholeness of the flexible pipes, of the pipe fitting and the components of the hydraulic circuit: check that there is no oil leakage in hydraulic circuit.	Replacement	USER / C.M.C.
Check that the electrical contacts are not slacken.	Reset connections	USER / C.M.C.
Check that there is no trace of clashes on the equipment.	 It is strictly forbidden to use the MEWP. Contact the Service.	C.M.C.

8.2 ► Weekly maintenance (or every 40 hours) ◀

Operations	by
Check the absence of splits, cracks, rust on the MEWP counter frame (use torches or lamps to inspect the internal part under the floor).	USER / C.M.C.
Check the cleanliness of the chassis engine and auxiliary motor* air filter.	USER / C.M.C.
Check the cleanliness of the hydraulic filters.	USER / C.M.C.



8.3 ▶ Monthly maintenance (or every 120 hours) ◀

Operations	by
Greasing of pins and movable parts.	USER / C.M.C.
Washing of the equipment.	USER / C.M.C.
Check the tightening of the bolts of the bearing, the geared motor and the frame.	USER / C.M.C.

8.4 ▶ Quarterly maintenance (or every 300 hours) ◀

Operations	by
Check the tightening of the bolts of the bearing, the geared motor and the frame.	USER / C.M.C.

8.5 ▶ Maintenance after the first 400 hours ◀

Operations	by
Replacement of the hydraulic filters.	USER / C.M.C.
Registration of the movement of the booms.	C.M.C.

8.6 ▶ Six-monthly maintenance (or every 750 hours) ◀

Operations	by
Replacement of the hydraulic filters (25 micron).	USER / C.M.C.
Complete check of the whole machine and note the results in the appropriate manual section.	USER / C.M.C.

8.7 ▶ Annual maintenance (or every 1500 hours) ◀

Operations	by
Replacement of hydraulic oil.	C.M.C.

For the replacement of the hydraulic oil, follow these instructions:

1. Place the machine in transport position with the oil at working temperature; to do that, operate some maneuver before proceeding with the above-described operations.
2. Suck in the oil from the tank;
3. Dismantle the hydraulic filter;
4. Replace the filter;
5. Fill the tank letting the oil pass through a filter with 25 micron filtration.

8.8 ▶ Biennial maintenance ◀

Operations	by
Complete check of the whole machine and note the results in the appropriate manual section.	C.M.C.

8.9 ▶ Five-yearly maintenance ◀

Operations	by
Complete check of the whole machine and note the results in the appropriate manual section.	C.M.C.



8.10 ▶ Safety rules during maintenance ◀



THE NON-OBSERVANCE OF ONE OF THE FOLLOWING SAFETY RULES CAN SERIOUSLY HARM PEOPLE OR CAUSE SEVERE DAMAGES TO THINGS OR PARTS OF THE EQUIPMENT OR OF THE MACHINE.

➔ To ensure the safety of the machine **the use of original spare parts installed by C.M.C. or by authorized repair shops is compulsory:** in fact, some components can be calibrated only c/or C.M.C. or in authorized workshops.



It is forbidden to perform maintenance operations when the MEWP moves: make sure that the parts to maintain are motionless and do these operations with the motor of the chassis stalled, taking the keys away from the panel;

➔ Perform the maintenance operations in a sufficiently large space and suited to the sizes of the truck: mark the area assigned for the maintenance operations by suited enclosure or by a red/white band ribbon and do not allow entrance to unauthorized staff.

➔ Do not modify or remove safety devices.

➔ Do not modify calibrated pieces.

➔ During the washing operation, do not lead the water jet directly on the electrical panels of the MEWP and do not use cleansing, aggressive chemicals dangerous for the components of the MEWP (rubber parts, painted parts, etc.).



It is forbidden to perform any intervention on parts of the MEWP, such as welding, piercing, and so on, without prior written authorization by C.M.C.

➔ Wear appropriate protective clothes (gloves, goggles, etc.).

➔ During maintenance operations, be careful not to damage the hydraulic circuit and avoid impurities in the circuit.

➔ Before any maintenance operation that involves the disassembly of hydraulic circuit parts, make sure that the system is not under pressure. In order to avoid violent emissions of oil, move all the levers of the control distributors, with the truck motor stalled and no component in movement.

8.11 ▶ Maintenance of endothermic engine ◀

The standard supplied engine has the following technical characteristics:

- Diesel engine KUBOTA D902-E4B (3 cylinders, four-stroke vertical heated to water):

Data	Value	Unit of measure
Cylinder capacity	0.898	l
Highest performance at 3200 RPM	16.1 21.6	kW HP
Minimum number of RPM	900-1000	RPM
Dry weight	158.73	lbs.
Starter motor power (12 V)	1.2	kW
Alternator power (12 V)	480	W

As regards the thorough maintenance of the supplied internal combustion engine, see the maintenance interventions indicated by the manufacturer on its website:

<https://www.kubotaengine.com/>

8.12 ▶ Maintenance of electric engine (*optional) ◀

The 110/120/230 V electric motor (*optional) is positioned inside the proper bonnet in the carriage side of the machine. Periodically verify the conditions of following engine components:

- power terminals: check tightness of nuts in the bolts and integrity of the insulators;
- fan: check the cleanliness of the vents;
- bearings: check efficiency status.

8.12.1 ▶ Maintenance of 48 V electric engine (*optional)

The 48 V electric engine with battery pack, provided as optional* in full lithium version, has the following technical characteristics:



Battery specifics		
Battery Composition	LiFePo4	
Typical Capacity	300	[Ah]
Cells Configuration	15S1P	
Rated Voltage	48	[V]
Maximum Voltage Fully Charge	54.8	[V]
Minimum Operative Voltage	42	[V]
Rated Discharge Current	30	[A]
Maximum Discharge Current	100 (electronically limited)	[A]
Rated Charge Current	30 A (0.3 C)	
DoD	80	[%]
Battery Life Cycle	>2000 Cycle@80%DoD or >3000 Cycle@70%DoD	
Operative temperature (during charge)	-20/+60*	[°C]
Operative temperature (during discharge)	-20/+60	[°C]
Battery Weight	70 approximately	[kg]
Maximum Output Power	4.8	[kW]
Rated Energy	4.32	[kWh]

*When charge is operated at less than 0°C the charge current is electronically limited at 10 A.

Battery charger specifics		
Voltage Input	100 - 240	Vac
Frequency Input	50 - 60	Hz
Maximum Output Voltage	>=60	V
Maximum Current	22	A
PWM Frequency	1	kHz
International Protection	IP20	
Weight	2,2	Kg
Dimension (L*W*H)	180x310x100	mm

8.13 ► Consumables for maintenance ◀

Hydraulic oil:

Gazpromneft Hydraulic	HDZ ISO	32	46
Density, 15 °C, kg/l	ASTM D1298	0,867	0,872
Kinematic Viscosity, 40 °C, mm ² /s	ASTM D445	32	46
Kinematic Viscosity, 100 °C, mm ² /s	ASTM D445	6,32	8,03
Viscosity Index	ASTM D2270	151	154
Pour Point, °C	ASTM D97	-42	-42
Flash Point COC, °C	ASTM D92	204	216
Air release, 50 °C, min	ISO DIS 9120	5	6
Copper corrosion, 3 hrs, 100°C	ASTM D130	1a	1a
FZG, Damaged Load, A/8,3/90	DIN 51354	12	12

(hydraulic tank capacity: 50 l)

Grease:

- for boom extension and outriggers:
Interflon Grease LS1/2
Composition: mixture of mineral oils, calcium-lithium complex thickener, additives and Teflon®.
(working field: from -20°C to +120°C)
- for lubricators and bearing:
WHITE STAR NLGI 0 E 2
Composition: mixture of mineral oils and additives.
(working field: from -30°C to +110°C)
- for chains:
Interflon LUBE EP+
Composition: mixture of mineral and vegetable oils, additives and Teflon®.
Density, 20°C: 0,89 g/cm³
Kinematic viscosity, 20°C (ASTM D2983): 380 mPa.



Before oil replacement, place an oil drip tray in order to avoid the leakage of oil in the environment. Do not disperse the exhausted oil or other consumables in the environment; put them in the appropriate containers and give them to the authorized collection centers.

8.14 ▶ Indications for the demolition of the MEWP ◀



In case of demolition, the machine must be dismantled completely according to the laws in force.



The different types of materials must be destined to the respective authorized centers of collection.

The following material must undergo differentiated disposal therefore placed in suitable places and containers:

- Ferrous materials: carpentries and mechanical components.
- Plastic materials: gaskets, straps, and protections.
- Electrical materials: windings, controls, electro valves and similar.
- Oils and lubricants: hydraulic oil, reducer lubricants, and lubricants greases.

8.15 ▶ Service ◀

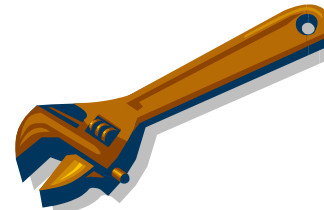

For repairs and maintenance of your platform, refer exclusively to:

**Service
C.M.C. s.r.l.**

Via Bitritto, 119
70124 BARI – ITALY
Tel. **+39 080 5326606**
+39 080 5326557
Fax: **+39 080 5368541**
E-mail: info@cmclift.com



PLEASE NOTICE:

FOR ANY COMMUNICATION, PLEASE SPECIFY MODEL AND SERIAL NUMBER OF THE MEWP.



Any operation requiring interventions on the components of the machine, shall be carried out by authorized and trained staff.



Non-authorized staff is not allowed to replace components.



Many components of the MEWP have been calibrated: a correct calibration of these parts (which is possible only in C.M.C. or in authorized repair shops) is necessary to assure the safety of the machine.

8.15.1 ▶ Remote Connection System (*optional)

The remote connection system is composed of an electronic box (Picture 96) mounted on the chassis, that allows to owner or manufacturer to connect remotely to the machine system.



Picture 96: remote connection system.

Remote connection procedure:

1. Ensure that the M12 socket on the remote connection box is correctly connected to the M12 plug of the electric box mounted on the chassis;
2. Share your Internet wireless network with the remote connection device in free mode (without password);
3. Lift the connection remote switch on the chassis box covered by a carter on the right side of the machine (Picture 97):



Picture 97: carter over the chassis box.

- the led on the remote connection box makes two red flashes,
 - after 30 seconds, the led becomes fixed and green, to show that the operating system is working,
 - it automatically hooks up to your free network;
4. Install on your PC the TeamViewer software (11th version) to connect to the machine system, through ID and Password supplied by the manufacturer;
 5. Call C.M.C. Service for technical assistance.



9 Troubleshooting



Any operation requiring interventions on the components of the machine shall be carried out by authorized and trained staff.



Non-authorized staff can't replace components. Many components of the MEWP have been calibrated: a correct calibration of these parts (which is possible only in C.M.C. or in authorized repair shops) is necessary to ensure the safety of the machine.

Issue: THE CONSENT LIGHT FOR STABILIZATION DOES NOT TURN ON.

- Causes:
1. The aerial part of the MEWP is not in transport position.
 2. Failure fuse 30A battery side.
 3. Defective board.
 4. Wire removed from the battery.

- Remedies:
1. Place the aerial part of the MEWP in transport position.
 2. Check if any cable is disconnected from the battery.
 3. Replace fuse.
 4. Replace the limit switches.

If the problem persists, contact the Service.

Issue: THE STABILIZERS DO NOT WORK.

- Causes:
1. The hydraulic pump unit is faulty.
 2. Stabilizers electrovalve do not work.

- Remedies:
1. Replace the hydraulic pump.
 2. Replace the stabilizers limit switches.

If the problem persists, contact the Service.

Issue: WITH THE MEWP STABILIZED, THE CONSENT LIGHT FOR AERIAL PART USE DOES NOT TURN ON.

- Cause:
1. The green light does not work.
 2. Micro-switch system does not work.
 3. Stabilization is incomplete.

- Remedies:
1. Replace led.
 2. Replace micro-switch.
 3. Further extract outriggers up to soil contact.

If the problem persists, contact the Service.

Issue: THE MEWP AERIAL PART DOES NOT WORK.

- Causes:
1. The hydraulic pump unit is faulty.
 2. Not having switched the deadman lever on control station.
 3. The exchange electrovalve is not energized.
 4. Emergency button activated.

- Remedies:
1. Replace the hydraulic pump.
 2. Turn on and connect the control station.
 3. Replace the exchange valve.
 4. Turn the emergency button and reset the MEWP.

If the problem persists, contact the Service.

Issue: THE BASKET LEVELLING DOES NOT WORK.

- Causes:
1. Oil leakage.
 2. Cylinder seals worn.

- Remedies:
1. Tighten the hydraulic connections.
 2. Replace the seals.

If the problem persists, contact the Service.



Issue: LOW MANOEUVRES SPEED.

- Causes:
1. Pump failure.
 2. Hydraulic oil level too low.
 3. Oil filter clogged.

- Remedies:
1. Replace the hydraulic pump.
 2. Refill hydraulic oil.
 3. Replace the filter.

If the problem persists, contact the Service.

Issue: IMPOSSIBLE TO START THE ENDOTHERMIC ENGINE.

- Causes:
1. Emergency activated.
 2. Battery discharged.
 3. Out of fuel.
 4. Hydraulic oil level too low.

- Remedies:
1. Disable the emergency button.
 2. Replace the battery.
 3. Refuel.
 4. Refill hydraulic oil.

If the problem persists, contact the Service.

The display on the wired remote control (par. 3.2.2) allows to read the machine operational conditions as well as to detect possible functional anomalies. Reading the corresponding possible error code and contacting our Service Centre, it is possible – at any moment – to detect and solve the problem.



Contact our Service Centre for any technical problem which is not identified nor solved by the aforesaid procedure.



10 ►► Sealings list ◀◀

For your information, hereby there is a list of the anti-tampering sealings present on the MEWP:

- emergency bypass;
- block travel bypass;
- engine stop bypass;
- outriggers monitored electrovalves;
- platform valves;
- proportional valves.



The tampering or replacement of components by non-authorized staff is strictly forbidden.

→ It is mandatory to restore the sealings after use of these items.



11 ▶▶ Overload tests ◀◀



During the commissioning of the machine, in the final test, we carried out the following overload tests. During it, we tested S32 stability and structural resistance.

With the machine at maximum working outreach, test loads are added to nominal load to perform mechanical evaluations and to obtain product certifications.



Overload tests shall be carried out only on the first test of the machine: these tests are unique. In no other occasion you shall carry out tests with the same loads used in the overload tests.



12 Operating tests



During the commissioning of the machine, we carried out the following final operation tests. We have tested the correct operation of the S32 and of its safety systems.

Test description	Outcome
▪ Block of the operation in case of release of the selected operation lever.	OK
▪ Basket levelling allowed only when the MEWP aerial part is set in the rest position (pantograph on its support and telescopic boom on its support).	OK
▪ Outriggers-booms operation interlock.	OK
▪ MEWP aerial part operations block when the MEWP is not stabilized	OK
▪ Block of the return/extension of outriggers when the MEWP aerial part is not set in the rest position.	OK
▪ Stabilized machine – signal light.	OK
▪ MEWP electrical power – signal light.	OK
▪ Aerial part use – signal light.	OK
▪ Chassis maximum inclination detector.	OK
▪ Rotating blinker (*optional) and acoustic warnings.	OK
▪ Emergency buttons in all control stations.	OK
▪ Lock valves on cylinders.	OK
▪ Safety relief valves for the protection of the whole hydraulic circuit.	OK
▪ Safety relief valves for the protection of the single parts of the system.	OK
▪ Electrical system protection fuse.	OK
▪ Moment limiting device (in wide and narrow areas).	OK
▪ Load limiting device.	OK

▪ Slowdown of the aerial part maneuvers.	OK
▪ Anti-collision system.	OK
▪ Manual pump for operations in case of emergency.	OK
▪ Electropump (*optional).	OK



13 ▶▶ Control register ◀◀

In this register note down the following events in the machine life cycle:

- Delivery of the MEWP to the first owner (par. 13.1)
- Following ownership transfers (par. 13.2)
- Replacement of mechanisms (par. 13.3)
- Replacement of structural elements (par. 13.4)
- Replacement of hydraulic components (par. 13.5)
- Replacement of electrical components (par. 13.6)
- Replacement of safety devices (par. 13.7)
- Considerable failures and relevant repairs (par. 13.8)
- Periodical checks and maintenance journal (par. 13.9)
- Notes (par. 13.10)

13.1 ▶ Delivery of the MEWP to the first owner ◀

CMC

The mobile elevating work platform
brand **C.M.C.**
model **S32**
serial number _____
manufacture year **2020**

has been delivered by C.M.C. s.r.l.
to the firm

according to the contractual conditions
established with the technical, dimensional and
functional features indicated in the use manual

date _____

C.M.C. s.r.l.



13.2 ▶ Following ownership transfers ◀

On the the ownership of the MEWP in subject is transferred to the firm/company

It is certified that, on the above date, the functional, dimensional and technical features of the MEWP in subject are in keeping with those foreseen at the beginning and that further changes have been written on this register.

The seller

The buyer

On the the ownership of the MEWP in subject is transferred to the firm/company

It is certified that, on the above date, the functional, dimensional and technical features of the MEWP in subject are in keeping with those foreseen at the beginning and that further changes have been written on this register.

The seller

The buyer

On the the ownership of the MEWP in subject is transferred to the firm/company

It is certified that, on the above date, the functional, dimensional and technical features of the MEWP in subject are in keeping with those foreseen at the beginning and that further changes have been written on this register.

The seller

The buyer

On the the ownership of the MEWP in subject is transferred to the firm/company

It is certified that, on the above date, the functional, dimensional and technical features of the MEWP in subject are in keeping with those foreseen at the beginning and that further changes have been written on this register.

The seller

The buyer



13.4 ▶ Replacement of structural elements ◀

Description of the component:

Manufacturer:

Provided by

Cause of the replacement:

.....

Place Date

Stamp and signature of the responsible
for the firm in charge The user

Description of the component:

Manufacturer:

Provided by

Cause of the replacement:

.....

Place Date

Stamp and signature of the responsible
for the firm in charge The user

Description of the component:

Manufacturer:

Provided by

Cause of the replacement:

.....

Place Date

Stamp and signature of the responsible
for the firm in charge The user

Description of the component:

Manufacturer:

Provided by

Cause of the replacement:

.....

Place Date

Stamp and signature of the responsible
for the firm in charge The user



13.5 ▶ Replacement of hydraulic components ◀

Description of the component:

Manufacturer:

Provided by

Cause of the replacement:

.....

Place Date

Stamp and signature of the responsible
for the firm in charge The user

Description of the component:

Manufacturer:

Provided by

Cause of the replacement:

.....

Place Date

Stamp and signature of the responsible
for the firm in charge The user

Description of the component:

Manufacturer:

Provided by

Cause of the replacement:

.....

Place Date

Stamp and signature of the responsible
for the firm in charge The user

Description of the component:

Manufacturer:

Provided by

Cause of the replacement:

.....

Place Date

Stamp and signature of the responsible
for the firm in charge The user



13.6 ▶ Replacement of electrical components ◀

Description of the component:

Manufacturer:

Provided by

Cause of the replacement:

.....

Place Date

Stamp and signature of the responsible
for the firm in charge The user

Description of the component:

Manufacturer:

Provided by

Cause of the replacement:

.....

Place Date

Stamp and signature of the responsible
for the firm in charge The user

Description of the component:

Manufacturer:

Provided by

Cause of the replacement:

.....

Place Date

Stamp and signature of the responsible
for the firm in charge The user

Description of the component:

Manufacturer:

Provided by

Cause of the replacement:

.....

Place Date

Stamp and signature of the responsible
for the firm in charge The user



13.7 ▶ Replacement of safety devices ◀

Description of the component:

Manufacturer:

Provided by

Cause of the replacement:

.....

Place Date

Stamp and signature of the responsible
for the firm in charge The user

Description of the component:

Manufacturer:

Provided by

Cause of the replacement:

.....

Place Date

Stamp and signature of the responsible
for the firm in charge The user

Description of the component:

Manufacturer:

Provided by

Cause of the replacement:

.....

Place Date

Stamp and signature of the responsible
for the firm in charge The user

Description of the component:

Manufacturer:

Provided by

Cause of the replacement:

.....

Place Date

Stamp and signature of the responsible
for the firm in charge The user



13.8 ▶ Considerable failures and relevant repairs ◀

Description of the failure:

.....

.....

Cause:

.....

.....

Repairs performed:

.....

.....

Place.....

Date.....

Stamp and signature of the responsible
for the firm in charge

The user

Description of the failure:

.....

.....

Cause:

.....

.....

Repairs performed:

.....

.....

Place.....

Date.....

Stamp and signature of the responsible
for the firm in charge

The user



13.9 ▶ Periodical checks and maintenance register ◀

➔ The user shall observe the maintenance and control program described in this manual.

DATE	SERVICE	SIGNATURE

DATE	SERVICE	SIGNATURE



DATE	SERVICE	SIGNATURE

DATE	SERVICE	SIGNATURE



▶▶ Index ◀◀

- 0 ▶▶ Introduction ◀◀ 1
 - 0.1 ▶ Content of the manual ◀ 1
 - 0.2 ▶ Disclaimer ◀ 2
 - 0.3 ▶ Where and how to store the manual ◀ 2
 - 0.4 ▶ Legislative references ◀ 2
 - 0.5 ▶ Changes and integrations ◀ 3
- 1 ▶▶ Specifications ◀◀ 4
 - 1.1 ▶ Technical sheet ◀ 4
 - 1.2 ▶ Identification plate ◀ 7
 - 1.3 ▶ CE certification ◀ 7
 - 1.4 ▶ TÜV certification ◀ 7
 - 1.5 ▶ Classification ◀ 7
 - 1.6 ▶ Loading cycles ◀ 8
 - 1.7 ▶ Working diagram ◀ 8
- 2 ▶▶ Description and purpose ◀◀ 10
 - 2.1 ▶ Machine definition ◀ 10
 - 2.2 ▶ Machine purpose ◀ 10
 - 2.3 ▶ Description of the main components ◀ 11
- 3 ▶▶ Control stations ◀◀ 13
 - 3.1 ▶ Machine switching on/off station ◀ 13
 - 3.2 ▶ Platform control stations ◀ 14
 - 3.3 ▶ Emergency control stations ◀ 20
- 4 ▶▶ Use procedures ◀◀ 21
 - 4.1 ▶ Environmental operational conditions ◀ 21
 - 4.2 ▶ Safety distances ◀ 22
 - 4.3 ▶ Transport, storage and packing ◀ 22
 - 4.4 ▶ MEWP use procedures ◀ 26
 - 4.5 ▶ Lithium battery pack recharge (*optional) ◀ 31
 - 4.6 ▶ Emergency operations ◀ 32
 - 4.7 ▶ Safety rules ◀ 38
 - 4.8 ▶ Safety devices ◀ 41
- 5 ▶▶ Markings ◀◀ 43
- 6 ▶▶ Electrical system ◀◀ 51

- 7 ▶▶ Hydraulic system ◀◀ 52
- 8 ▶▶ Maintenance ◀◀ 53
 - 8.1 ▶ Daily maintenance ◀ 53
 - 8.2 ▶ Weekly maintenance (or every 40 hours) ◀ 55
 - 8.3 ▶ Monthly maintenance (or every 120 hours) ◀ 56
 - 8.4 ▶ Quarterly maintenance (or every 300 hours) ◀ 56
 - 8.5 ▶ Maintenance after the first 400 hours ◀ 56
 - 8.6 ▶ Six-monthly maintenance (or every 750 hours) ◀ 56
 - 8.7 ▶ Annual maintenance (or every 1500 hours) ◀ 56
 - 8.8 ▶ Biennial maintenance ◀ 56
 - 8.9 ▶ Five-yearly maintenance ◀ 56
 - 8.10 ▶ Safety rules during maintenance ◀ 57
 - 8.11 ▶ Maintenance of endothermic engine ◀ 57
 - 8.12 ▶ Maintenance of electric engine (*optional) ◀ 57
 - 8.13 ▶ Consumables for maintenance ◀ 58
 - 8.14 ▶ Indications for the demolition of the MEWP ◀ 59
 - 8.15 ▶ Service ◀ 59
- 9 ▶▶ Troubleshooting ◀◀ 61
- 10 ▶▶ Sealings list ◀◀ 63
- 11 ▶▶ Overload tests ◀◀ 64
- 12 ▶▶ Operating tests ◀◀ 65
- 13 ▶▶ Control register ◀◀ 66
 - 13.1 ▶ Delivery of the MEWP to the first owner ◀ 66
 - 13.2 ▶ Following ownership transfers ◀ 67
 - 13.3 ▶ Replacement of mechanisms ◀ 68
 - 13.4 ▶ Replacement of structural elements ◀ 69
 - 13.5 ▶ Replacement of hydraulic components ◀ 70
 - 13.6 ▶ Replacement of electrical components ◀ 71
 - 13.7 ▶ Replacement of safety devices ◀ 72
 - 13.8 ▶ Considerable failures and relevant repairs ◀ 73
 - 13.9 ▶ Periodical checks and maintenance register ◀ 74
 - 13.10 ▶ Notes ◀ 76